

ROTARY SLOPE MOWER



OPERATION MANUAL 2SGS (s.n. 3853 -)

Operation manual

Revision 01-01-01-2019



Product serial number:

Engine type:

Engine serial number:

DVOŘÁK – svahové sekačky s.r.o.
Pohled 277, 582 21 Pohled
Czech Republic
Tel: +420 564 036 099
Mail: info@spider-cz.com
Web: www.spider-cz.com

1 CONTENTS

1 CONTENTS	2
2 INTRODUCTION	4
2.1 IMPORTANT	4
2.2 MACHINE USAGE.....	5
2.3 PROHIBITED USE.....	6
2.4 PRODUCT IDENTIFICATION.....	7
2.5 GUIDELINES FOR THE DISPOSAL OF SCRAP PRODUCTS.....	7
3 SAFETY INSTRUCTIONS.....	8
4 SPECIFICATION	11
4.1 SPECIFICATION	11
4.2 NOISE EMISSIONS	11
4.3.CONFORMITY CERTIFICATES.....	12
4.4. CERTIFICATE OF STABILITY	13
5 DECALS	14
5.1 RECOMMENDED METHODS OF OPERATION.....	16
6 CONTROLS.....	19
6.1 REMOTE RADIO CONTROLLER NBB	19
6.2 MOWER CONTROLS.....	20
7 DISPLAYS	21
7.1 NBB RADIO CONTROLLED DISPLAYS.....	21
7.2 MOWER DISPLAYS	21
8 SAFETY SYSTEMS	22
8.1 MOWER SAFETY SYSTEMS	22
9. PREPARING THE MACHINE	23
9.1 MACHINE DELIVERY TO A DEALER OR RETAILER	23
9.2 HYDRAULIC PUMP BY-PASS.....	24
9.3 CHECKING ENGINE OIL LEVEL	24
9.4 CHECKING HYDRAULIC DRIVE OIL LEVEL	25
9.5 PREPARING THE BATTERY.....	25
9.6 FUEL TANK.....	26
9.7 PREPARING THE NBB REMOTE RADIO CONTROLLER	26
9.8 CHARGING THE NBB REMOTE RADIO CONTROLLER BATTERY	26
10 OPERATION.....	27
10.1 TRANSPORTING THE MOWER.....	27
10.2. STARTING THE ENGINE OF THE MOWER	27
10.3 SHUTTING OFF THE ENGINE	28
10.4 EMERGENCY SHUTTING OFF OF THE ENGINE	28
10.5 ENGAGING THE BLADES.....	29
10.6 DISENGAGING THE BLADES	29
10.7 HEIGHT OF CUT ADJUSTMENT	29
10.8 ENGAGING THE WINCH	29
10.9 DRIVING THE MACHINE	30
10.10 DRIVING SPEED OF THE MOWER	30
10.11 DRIVING ON SLOPES	31
10.12 STOPPING THE MACHINE ON A SLOPE	31
10.13 SKID STEERING	31
11 MAINTENANCE AND LUBRICATION	32
11.1 MAINTENANCE CHART - MOWER	32
11.2 MAINTENANCE CHART – ENGINE	33
11.3 ENGINE MAINTENANCE.....	34
11.4 CHANGE THE ENGINE OIL.....	34
11.5 CLEANING THE FUEL TANK.....	35
11.6 MAINTAINING THE HYDRAULIC DRIVE.....	35
11.7 CHECKING AND REFILLING OIL	35
11.8 ADJUSTMENT OF THE NEUTRAL POSTION OF THE HYDRAULIC DRIVE	35
11.9 DRIVE V-BELTS.....	37
11.10 GEOMETRY ADJUSTMENT	37
11.11 FINAL GEAR DRIVE TO WHEELS.....	38
11.12 MAINTAINING ELECTRIC CIRCUITS AND DEVICES, TRANSMITTER	38
11.13 ADJUSTING BLADE DECELERATION	38
11.14 STEERING CHAIN	39
11.15 FUSES	39
11.16 MOWING BLADES.....	40

11.17 CHANGING THE WHEEL	41
11.18 TYRE PRESSURE	41
11.19 MOWING HEIGHT ADJUSTMENT MECHANISM	41
11.20 LUBRICATION	41
11.21 CLEANING THE MACHINE	42
11.22 TORQUE CHART	42
11.23 TECHNICAL PLATE.....	43
11.24 TOOLS.....	43
11.25 AUXILIARY DRIVE BRAKE	44
11.26 BATTERY MAINTENANCE.....	45
12 TROUBLESHOOTING	46
13 MAINTENANCE AFTER SEASON	49
14 WARRANTY CONDITIONS	51
15 SERVICE RECORDS	53

2 INTRODUCTION

2.1 IMPORTANT



This is a precision machine and the service obtained from it depends on the way it is operated and maintained.

This OPERATION MANUAL should be regarded as part of the machine and should always be present at the machine and available to the operator. Suppliers of both new and second-hand machines are advised to retain documentary evidence that this manual was provided with the machine.

This machine is designed solely for use in customary grass cutting operations. Use in any other way is considered as contrary to the intended use. Compliance with and strict adherence to the conditions of operation, service and repair as specified by the manufacturer, also constitute essential element of the intended use.

Before attempting to operate this machine, ALL operators MUST go through a practical training in machine usage, read through this manual and make themselves thoroughly conversant with Safety Instructions, controls, lubrication and maintenance. The machine may be operated with additional accessories specifically designed for this purpose. Operating and Safety Instructions of such accessories must be strictly adhered to.

Accident prevention regulations, all other generally recognized regulations on safety and occupational medicine, and all road traffic regulations shall be observed at all times.

Any arbitrary modifications carried out on this machine as well as non-adherence to this OPERATION MANUAL may relieve the manufacturer of liability for any resulting damage or injury.

In several places this Manual contains instructions for safe work. If the text includes such an instruction, then the instruction is marked by the following WARNING symbol:



Warning against a highly probable danger of severe injury or life threat if appropriate instructions are not followed.



other symbols:



Provides useful information.

2.2 MACHINE USAGE

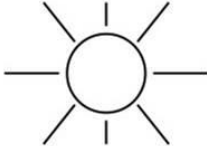
The machine is designed for the mowing of grass on level as well as extremely steep terrain. Any other use is prohibited. **The maximum slope** on which the machine may be used depends on the type of area to be mowed, on the current condition of the area and on the method of mowing:

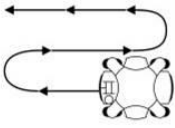
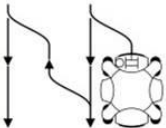
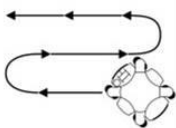
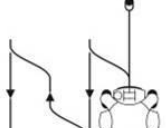
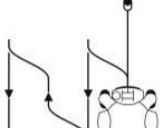
					
					
MAX 35°	MAX 36°	MAX 41°	20°-55°	MAX 20°	20°-55°

DRY CONDITIONS:

Cutting across a slope:	Maximum slope is 35°
Cutting up and down a slope:	Maximum slope is 36°
Cutting across a slope with mower positioned diagonally:	Maximum slope is 41°
Cutting up and down a slope with use of the integrated stabilizing winch	Maximum slope is 55°

WET CONDITIONS:

<i>All areas and applications without use of the integrated stabilizing winch:</i>	Maximum slope is 20°
<i>Cutting up and down a slope with use of the integrated stabilizing winch:</i>	Maximum slope is 55°

The Spider is a mulching mower designed for mowing of well-maintained, but also unkept or only occasionally mowed areas. The mower is operated by one person using radio control.

The mower may only be operated by authorized persons over 18 years of age both mentally and physically fit, who are familiar with this Safety, Operator's and Maintenance Manual and all applicable regulations and laws pertaining to work health and safety that need to be observed while operating the mulching mower Spider.

For use of the integrated stabilizing winch it is obligatory to have read the Operation manual Winch HSN 02 and be properly trained by the seller on how to use the integrated stabilizing winch.

When driving on a slope the operator of the machine must carefully watch and evaluate the movements of the mower and the characteristics of the terrain, especially the momentary adhesion of the wheels to the ground.

Pay attention to climatic conditions. Do not rely on the anchoring of the mower on the rope. Climbing ability of the mower will rapidly change on dry, wet or moist grass.

The soil characteristics and firmness will also play a significant role. Sideslip will be much bigger on newly built slopes than on hard ground. When working on a slope with the integrated stabilizing winch use only one driving method: driving vertically / up and down a slope.

2.3 PROHIBITED USE

- The mower may not be used for other purpose than for which it was designed, and which is described in chapter 2.2.
- The mower may not be used on surfaces littered by glass, loose stones, pieces of iron and other foreign objects that can either be thrown by the blades during mowing or damage the mower.
- The mower may not be used on slopes exceeding 20 degrees when wet or foggy without use of the integrated stabilizing winch, as the climbing ability and mower stability are adversely influenced by poor ground adhesion, regardless of the type of area to be mowed.
- The mower may not be used where other people, children or animals can be found within 3 m (10 ft.) from the mower/mowed area.
- **Never use the mower unless you are properly acquainted with the terrain and mainly with the occurrence of undesired terrain irregularities, stumps, swamps, pits, unstable and poor load bearing soil etc.**
- The mower may not be used on slopes with incline exceeding the values stated in chapter 2.2.
- The mower may not be used as a towing/transporting device or as means of transporting persons.
- It is prohibited to drive the mower on public thoroughfares.
- It is prohibited to increase the engine revolutions or the engine performance above the limits specified by the manufacturer. It is also prohibited to make any other modifications to the machine construction or to the engine setup. The manufacturer does not bear any liability for damage or injury resulting from such modifications.
- It is prohibited to use the mower under the influence of alcohol or drugs
- It is prohibited to drive the mower into heaps of sand, gravel or similar material, on stumps, rocks, construction elements or any other obstacle, which may compromise the stability of the machine
- It is prohibited to use the machine under low visibility (dusk, fog, heavy rain etc.)

2.4 PRODUCT IDENTIFICATION

On the internal engine you can also find a factory label placed there by the engine manufacturer.



Engine factory label location

Mower factory label location

2.5 GUIDELINES FOR THE DISPOSAL OF SCRAP PRODUCTS

When it has been identified that a turf care product has no further functional value and requires disposal, the following actions should be taken.

These guidelines should be used in conjunction with Health, Safety and Environmental legislation and use of approved local facilities for waste disposal and recycling.

- Use appropriate tools and Personal Protective Equipment (PPE) and take guidance from the technical manuals applicable to the machine.
- Remove and store appropriately:
 1. Batteries
 2. Fuel Residue
 3. Oils
- Disassemble the structure of the machine referring to the technical manuals where appropriate. Special attention should be made for dealing with “stored energy” within pressurized elements of the machine or tensioned springs.
- Any items that still have a useful service life as second-hand components or can be re-serviced should be separated and returned to the relevant centre.

- Other worn out items should be separated into material groups for recycling and disposal consistent with available facilities. More common separation types are as follows:
 - Steel
 - Nonferrous metals
 - Aluminium
 - Brass
 - Copper
 - Plastics
 - Identifiable
 - Recyclable
 - Non-recyclable
 - Non-identified
 - Rubber
 - Electrical and electronic components
- Items that cannot be separated economically into different material groups should be added to the “General waste” area.
- Do not incinerate waste.

Finally update machinery records to indicate that the machine has been taken out of service and scrapped.

3 SAFETY INSTRUCTIONS



This safety symbol indicates important safety messages in this manual. When you see this symbol, be alert to the possibility of injury, carefully read the message that follows, and inform other operators.

Safety Checks

- Do not enter or reach under the machine if it is lifted and not sufficiently supported. The machine should be supported on places marked by the symbol of a lifting jack.
- The mower should only be transported in a container or on a trailer.
- Check bolt torques at regular intervals. The first check should be done after 8 operating hours. Pay attention to the attachment of the cutting blade and the proper bolt torque. Use a torque wrench and a specified torque. See 11.22.
- The attaching flange of the blades or the bolts must not show sign of damage or wear. The bolts must be complete. The blade must be undamaged, evenly worn and adequately sharp.
- If you are driving the machine outside of the working area, always turn off the mowing blades and set the maximum mowing height, otherwise the blades may get damaged.
- Keep the product clean after use. Do not use gasoline or similar oil products for cleaning.
- Do not reach into the space under the mower with your hands or feet. Do not reach under the engine cover or into the gear mechanism.
- If you are forced to reach under the machine, wait until all rotating parts stop. Attention, it takes some time before blade runs down! The run-down time depends on the state and wear of the brake/clutch. Have the brake checked at regular intervals at an authorised servicing facility.
- While operating, wear closed shoes and work clothing. Do not wear loose clothes that could get caught by the machine, short trousers or light shoes.
- It is strictly prohibited for the operator to wear loose clothing.
- A local risk assessment should determine the need for a face shield.
- Do not operate the machine after drinking alcohol or using medication influencing perception.
- Before starting the engine, make sure that the mower blade is disengaged. If the blade switch is in the ON position, the machine cannot be started. When engaging the mower blade, step aside far enough to be protected against object accidentally thrown from the mower and to be

able to stop the mower in case of an emergency. Do not enter the path of the mower.

- While operating the mower make sure that the mower is clearly visible at all times and within the range of the remote control unit and that you can clearly recognize dangerous situations and react to them properly. Do not abuse the maximum reach of the remote control.
- When using the mower, follow all general work safety regulations.
- Work with the mower may only be started if the mower is not damaged by previous operation.
- Do not change the engine tuning, especially the engine speed regulator. Do not modify the exhaust pipe.
- Do not use the mower if there is less than 30% of fuel in the fuel tank.
- Do not move the mower by means of towing it behind another machine.

Operating Environment

- The machine should only be used by persons over 18 years of age, who have been acquainted with the machine and the user's manual. The remote control (further referred to as "RC") is considered as a part of the machine
- The user's manual must be stored in a place permanently accessible to the operator and must be available to him at all times.
- Do not allow children or unauthorised persons use the product.
- Before starting to operate the machine, you have to be familiar with all the symbols next to the controls and indicators used on the mower and the RC.
- Pay special attention to the stopping and shutting-off of the engine and to the emergency shutting-off of the mower.
- Before using the mower on a slope, make sure you test and practice your mower-control skills on flat and level ground, which is sufficiently free and spacious. Master how to control the movement on a surface, to mow around bushes, trees and other terrain elements and obstacles.
- When operating the mower on slope, make sure that the engine revolutions are set to maximum speed. If you stop the mower on a slope, position the wheels across the slope.
- While operating or transporting the mower, the operator must always have the mower in their view. The maximum distance between the operator and the mower is 50 m/165 ft.
- While using the mower follow all safety regulations given in this manual and respect

local regulations and provisions concerning noise-emissions, especially when using in hospitals, spas and other sensitive areas.

- The operator must pay attention to the area into which the mulched grass may be thrown. Neither the operator, nor any other persons, children nor animals should be allowed to enter this area. If mowing uneven terrain, the ejection and throwing of undesirable objects becomes more probable due to the displacement of the mowing device (tilt of one side of the machine) while crossing the edges of different terrain.
- The operator of the machine may be responsible for any damage caused to third parties by operating the machine.
- The mower may be used on dry surface on slopes listed in chapter 2.2. On wet or moist surfaces, the mowed slope should not exceed 20 degrees when using the machine without use of the integrated stabilizing winch.
- Before operating the machine, make sure you remove all loose stones, sticks, glass, wire, bones, branches and all other objects that can be picked up by the blades and thrown or that could damage the mower from the mowing area..
- While operating the mower avoid obstacles, do not drive over higher obstacles (such as stones, stumps, brick), near precipices, on unstable soil or in places where the mower could fall down or flip over.
- When operating pay attention to electric power lines especially when driving beneath electric wires where the radio signal may be lost. In such case the mower immediately shuts off the internal combustion engine and stops all movements.
- When using the machine near busy thoroughfares make sure that the mower does not endanger (by throwing undesirable objects) passers-by or their property. Choose a suitable working procedure (see chapter: Operating the mower).
- The operator/user is responsible for the safety of persons that enter the working area of the machine. Stop your work if these persons enter the working area.
- The transportation of persons, animals or loads on the mower is prohibited.
- Do not place any objects or tools on the product.
- While operating, especially in windy conditions, choose the operator's position carefully so as to keep the operator away from the stream of exhaust gas, dust or mulched grass.
- Stop work and clean the machine and its cooling surfaces several times while working in dusty conditions to avoid over-heating during operation. If necessary, clean the machine and its cooling surfaces several times while working. The dust layer must not exceed 1 mm.
- Refuel only when the machine is off – before operating, if possible – and the fuel tank is cold. Always keep at least 30% of the fuel in the tank. If you need to refuel during your work, do not fill the fuel into a hot tank or while the engine is still hot. Let the machine cool down.
- Before refuelling push the STOP button on the control panel of the mower.
- Never refuel while the engine is running.
- Do not start the engine if you find spilled fuel, open vessels with fuel or other combustible objects or gases in the immediate proximity of the mower.
- Do not refuel near open fire.
- Do not place this product near open fire or other sources of heat.
- While operating or immediately after shutting the machine off do not touch those parts of the machine that heat up during operation. This concerns mainly the engine exhaust pipe, metal parts of the hydraulic drive and metal parts of the internal combustion engine.
- While operating do not touch the high voltage conductor leading to the sparking plug.
- After starting the engine, test the correct functioning of the emergency engine stop on the radio transmitter. This function should be checked at least once during every shift and every time you enter a new area for mowing or mulching.
- Before starting your work test the correct functioning of the safety components (EMERGENCY STOP...) on the mower and the RC.
- Never leave the engine running without supervision.
- If the engine is running, do not put aside the transmitter and do not touch or move any parts of the machine.
- Always stop the engine when leaving the machine, secure it against starting by pushing the red EMERGENCY STOP button on the control panel of mower and by removing the key. Never leave the transmitter next to the mower, but put it in a different, properly secured place inaccessible to third persons.
- Do not engage the mowing blade until immediately before mowing.
- Turn off the mowing mechanism, shut off the engine and remove the key from the ignition every time:
 - You clean the machine
 - You remove dirt from the mowing mechanism (grass or debris).
 - You run over an unknown object and need to check for possible damage or to repair it

- The machine unusually intensively vibrates, and you need to find the cause
- You repair the engine or other parts of the mower (also unplug cables from sparking plugs)
- While operating, avoid molehills, concrete bases, guard-stones, stumps, loose stones and curbs. These must not come into direct contact with the blade as they could cause serious damage. These may also compromise the mower stability.
- Do not drive the mower into heaps of sand, gravel or similar materials
- The mower may only be operated during daylight or under very good artificial light conditions.
- Do not use the mower in limited visibility (dusk, fog, heavy rain etc.)
- Do not let the engine run in enclosed spaces. The exhaust gases contain CO. They damage health and can ultimately cause death.
- The engine should only be started and operating in open spaces. If the engine is started and operated in enclosed spaces, the exhaust gases must be conducted away by the means of prolonging the exhaust pipe outside the enclosed space. Proper ventilation and fresh air supply must be secured in order to prevent the accumulation of CO.
- Before storing the machine in a closed space, let the engine and the hydraulic drive of the machine cool properly.
- Regularly remove all combustible objects (dry grass, leaves...) from the areas around the exhaust pipe, engine, and battery.
- Always control the machine from a working station, which gives you a perfect view of the whole working area and of the machine.
- While working, change your working position to have a perfect view of the mower at all times.
- When operating the mower on slopes never enter the space directly below or above the mower.
- The working position should be far enough (maximum 50 m / 165 ft.) to prevent the operator from getting hit by objects that may be accidentally thrown by the mower.
- Do not operate the mower if you cannot see it (behind terrain obstacles, corners of buildings, hidden in grass etc.)

Safety Decals

- Before starting the mower, check the state of the safety labels. If any labels are damaged or missing, contact your dealer and replace such labels on the machine. Get thoroughly acquainted with these labels. The placement of the labels on the machine is obligatory.
- Do not remove or damage any of the safety labels.
- Do not remove any covers or safety elements. They are for your protection.
- Do not use the machine if any of the protecting devices or covers is damaged or missing.
- Keep the machine and its accessories clean and in a good technical condition at all times.
- It is strictly prohibited to make any changes or modifications to the machine that were not previously approved by the manufacturer. Any modification to the machine may lead to a hazardous situation or injury. If these instructions are not followed, the manufacturer does not bear any liability for the machine and the terms of warranty may be invalidated.
- The machine must always be equipped with all covers and protective elements.
- It is strictly forbidden to use the machine with improperly mounted or damaged rubber mulching cover with chains.

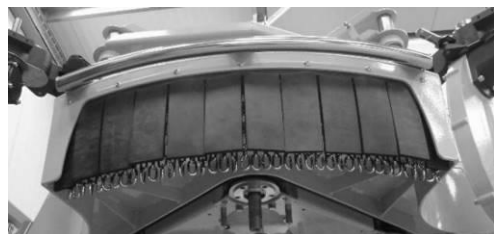

4.3. CONFORMITY CERTIFICATES

EC DECLARATION OF CONFORMITY

We manufacturer **DVOŘÁK - svahové sekačky s.r.o.**
Pohled 277, 582 21 Pohled
VAT ID: CZ26013797

declare that the product
 name: **Slope applicable rotary mower**
 model: **SPIDER 2SGS**
 designed for: **mowing of grass areas**
 serial number:

fulfils all the relevant provisions of Directives
Directive 2006/42/EC – machinery
Directive 2014/30/EC - EMC
Directive 2000/14/EC - noise
Directive 2014/53/EU
Regulation 2016/1628/EU

List of technical standards, specification and harmonised norms used for review of its conformity:
EN ISO 4254-1, EN ISO 4254-12, EN ISO 5395-1+A1, EN ISO 5395-3+A1+A2, EN ISO 14120, EN 1005-3+A1, EN 1175-2+A1, EN 55012 ed.2, EN ISO 3744, ISO 3767-1,3, EN ISO 4413, EN ISO 11 201, EN ISO 12100, EN ISO 19353, EN ISO 13732-1, EN ISO 13849-1, EN ISO 13850, EN 60215+A1, EN 300-220-03, EN 300-220-2, ISO 11 684

Description, basic technical specification

Parameter	Unit	Value
dimension	mm	1640 × 1430
height	mm	825
mowing width	mm	1230
weight	kg	365
driving speed	kmph	0 - 8
engine	-	KAWASAKI FS691V
performance/speed	kW	17,9/3600
engine speed	rpm	2900

Conformity assessment in accordance with directives 2000/14/EC, art 14, point 1

The person participating in this conformity assessment in accordance with directives 2000/14/EC:
 NB 1017, TÜV SÜD Czech s.r.o., Novodvorská 994, CZ – 142 21 Praha 4

Measured sound pressure emission level **L_{WA} = 98,7 dB**
 Guaranteed sound pressure emission level **L_{WA} = 100,0 dB**

The person authorized to compile the technical file **Jakub Trachtulec**
DVOŘÁK - svahové sekačky s.r.o.
Pohled 277
CZ – 582 21 Pohled

In Pohled on 15.10.2018

 **spider**®
 DVOŘÁK - svahové sekačky s.r.o.
 Pohled 277, 582 21 Pohled
 IČ: 26013797, DIČ: CZ26013797

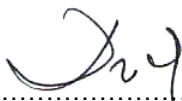





 Lubomír Dvořák, CEO

4.4. CERTIFICATE OF STABILITY

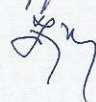
STÁTNÍ ZKUŠEBNA STROJŮ a.s.
THE GOVERNMENT TESTING LABORATORY OF MACHINES J.S.C.
 Třanovského 622/11, CZ-163 04 Praha 6-Řepy, Česká republika / *the Czech Republic*

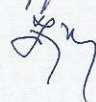
CERTIFIKÁT / CERTIFICATE

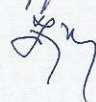
1. Výrobce / <i>Producer:</i> DVOŘÁK – svahové sekačky s.r.o. Pohled 277 CZ-582 21 Pohled Česká republika / <i>the Czech Republic</i>	2. Číslo certifikátu / <i>Certificate No.:</i> <p style="text-align: center;">4/2017</p>						
3. Držitel certifikátu / <i>Certificate keeper:</i> DVOŘÁK – svahové sekačky s.r.o. Pohled 277 CZ-582 21 Pohled Česká republika / <i>the Czech Republic</i>	4. Shoda s předpisy / <i>Conformity with regulations:</i> <p style="text-align: center;">---</p>						
5. Výsledky / <i>Results</i> * Protokoly o zkoušce vydané Státní zkušebnou strojů a.s. č. / <i>The Test Protocols issued by the Government Testing Laboratory of Machines J.S.C.</i> No.: 37 461, 37 462 ze dne / <i>of:</i> 2017-10-06	6. Použité normy / <i>Applied standards:</i> Zkušební postup požadovaný výrobcem. / <i>Test procedure required by the Producer.</i>						
7. Výrobek / <i>Product:</i> Dálkově ovládaná svahová sekačka SPIDER typ ILD01 G a ILD02 SG / Remote operated slope mower SPIDER type ILD01 G and ILD02 SG							
8. Popis výrobku / <i>Product description:</i> *							
9. Místo / <i>Place of issue:</i> Praha / Prague	10. Datum / <i>Date of issue:</i> 2017-10-11						
11. Podpisy / <i>Signatures:</i> <table style="width: 100%; border: none;"> <tr> <td style="width: 30%;">Vedoucí certifikace / <i>Head of Certification:</i></td> <td style="width: 30%;">Ing. Vratislav Zykán</td> <td style="width: 40%;">Podpis / <i>Signature:</i> </td> </tr> <tr> <td>Předseda představenstva společnosti / <i>Company Chairman of the Board:</i></td> <td>Ing. Zbyněk Jeřábek, MBA, Ph.D.</td> <td>Podpis / <i>Signature:</i> </td> </tr> </table> <div style="text-align: center; margin-top: 20px;">  Razítko / <i>Stamp</i> </div>		Vedoucí certifikace / <i>Head of Certification:</i>	Ing. Vratislav Zykán	Podpis / <i>Signature:</i> 	Předseda představenstva společnosti / <i>Company Chairman of the Board:</i>	Ing. Zbyněk Jeřábek, MBA, Ph.D.	Podpis / <i>Signature:</i> 
Vedoucí certifikace / <i>Head of Certification:</i>	Ing. Vratislav Zykán	Podpis / <i>Signature:</i> 					
Předseda představenstva společnosti / <i>Company Chairman of the Board:</i>	Ing. Zbyněk Jeřábek, MBA, Ph.D.	Podpis / <i>Signature:</i> 					



Tento certifikát je nepřenositelný a platí jen za podmínek zde uvedených, osvědčuje pouze skutečnosti zde uvedené.
 Smí být použit pouze vcelku, bez výpisů či zkracování. /
*The certificate is not transferable, it is valid exclusively under the conditions mentioned herewith.
 It shall be used only in a complete version, without any extract, abridgement or complement.*

* viz údaje na zadní straně tohoto Certifikátu / *see information on the back side of this Certificate*

* Další informace / Other information

5. Výsledky zkoušky / Test results:				
Statická stabilita / Static stability				
	SPIDER ILD01 G		SPIDER ILD02 SG	
	Volně stojící stroj / Free standing machine [°]	Stroj zajištěný kotvícím lanem a zatížením kotvícího lana / Machine secured by anchor rope and load of anchoring rope [°]/[kN]	Volně stojící stroj / Free standing machine [°]	Stroj zajištěný kotvícím lanem a zatížením kotvícího lana / Machine secured by anchor rope and load of anchoring rope [°]/[kN]
Kola směrem do svahu / Wheels towards the slope	48	55/0.95	49	60/1.6
Kola napříč ke svahu / Wheels across the slope	49	59/1.2	48	55/1.4

8. Popis / Description:

Rádiově dálkově ovládaná svahová sekačka. Hydrostatický pohon všech kol. Všechna kola říditelná. Šířka záběru žacího ústrojí: 80/123 [cm]. Pojezdová rychlost: 0-7/0-8 [km.h⁻¹]. Motor: Kawasaki FS541V/ Kawasaki FS691V, zážehový, výkon/otáčky: FS541V: 13,4 kW/3 600 min⁻¹, FS691V: 17,9 kW/3 600 min⁻¹ (údaj výrobce stroje). Hmotnost (naměřená): 289/375 [kg]. S jisticím navijákem HSN 02. / Radio remote operated slope mower. With hydrostatic all-wheel drive. All wheels are steerable. Cutting width of cutting means: 80/123 [cm]. Travel speed: 0-7/0-8 [km.h⁻¹]. Engine: Kawasaki FS541V/Kawasaki FS691V, spark-ignition, power/speed: FS541V: 13,4 kW/3 600 min⁻¹, FS691V: 17,9 kW/3 600 min⁻¹ (producer's machine indication). Weight (measured): 289/375 [kg]. With safety winch HSN 02.



5 DECALS

Attention! This machine may be dangerous. Incorrect and negligent use may result in damage, serious injuries or death. This chapter is devoted to the safety symbols (pictograms) used on the product, their placement and meaning. Safety labels inform the operator about risks while using the product. Understanding their meaning will make the use of this product safe.

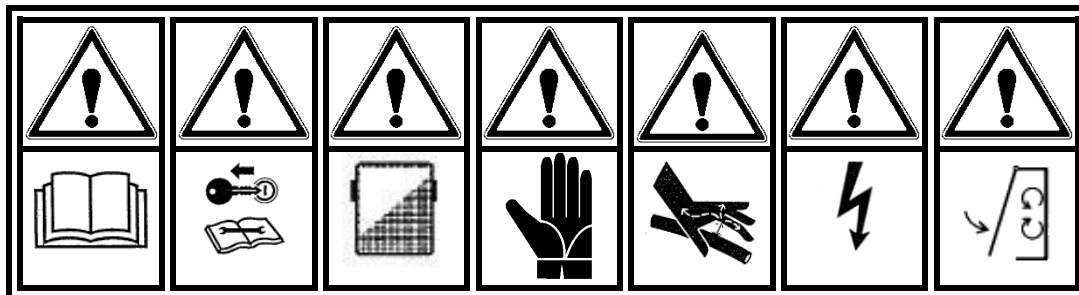

1	2	3	4	5	6	7
Read the user's manual before use	While maintaining, repairing or adjusting the mower, follow the user's manual and remove the key from the ignition	Use protective work aids; face shield	Attention, use protective gloves when changing the mowing blades	Attention, the device uses hydraulic energy drive, danger of injury caused by the squirting hydraulic oil	Attention, electric accumulator	Before starting close all protective covers

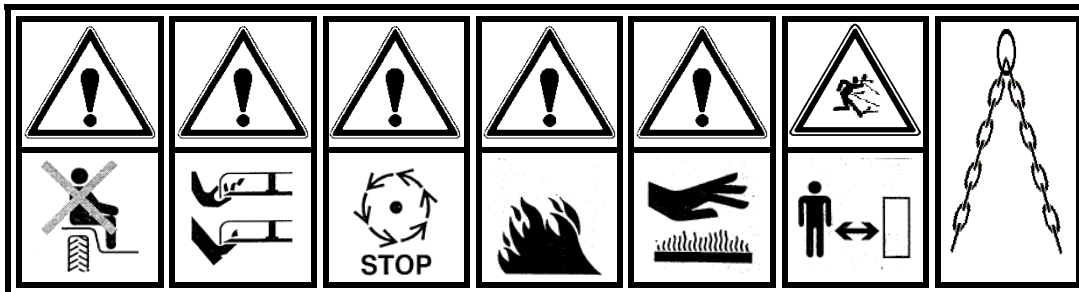

8	9	10	11	12	13	14
Transportation of persons on the machine is prohibited	Attention, danger of hand or feet injury caused by rotating blades	Attention, rotating parts are decelerating after they were turned off	Attention, combustible substance, danger of fire	Danger of getting burned by hot parts	Attention, danger of getting hit by flying object. Keep safe distance.	Slings point

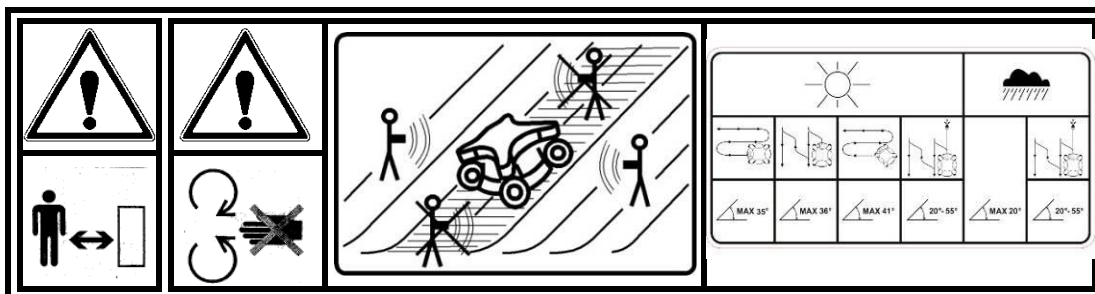

15	16	17	18
Keep safe distance from the machine when it is moving	Attention, rotating parts	On a slope never enter the area below or directly above the machine	Maximum permissible slope with regards to machine application and climatic conditions.

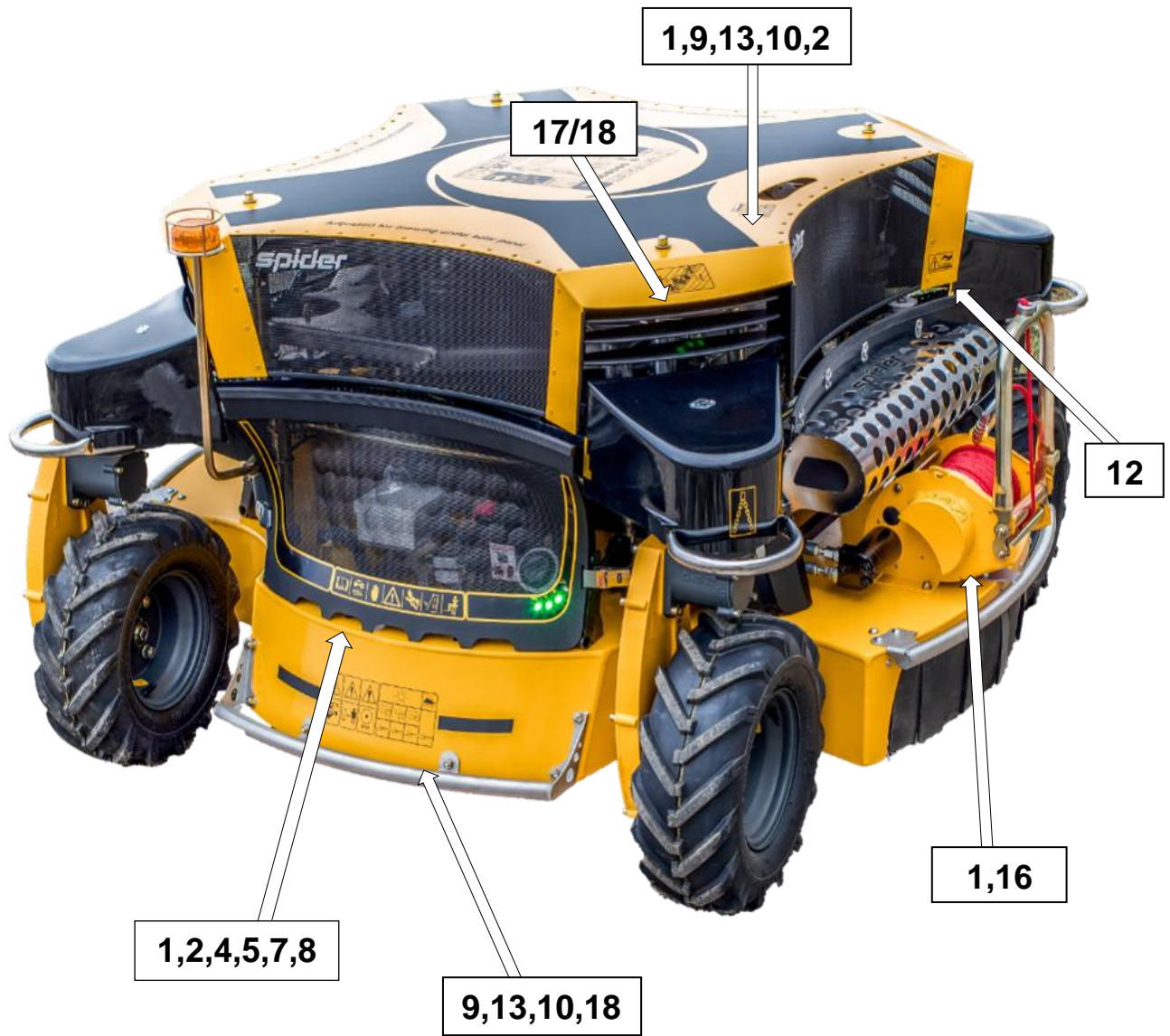

5.1 RECOMMENDED METHODS OF OPERATION

This chart shows basic information about recommended methods of cutting grass in various types of terrain. It also describes the correct procedure of anchoring the hydrostatic stabilizing winch. However current terrain and climatic conditions may require different methods of operation than those shown in this chart. The operator is always responsible for choosing the most suitable method of operation especially with regards to safety. In any case it is always absolutely necessary to comply with all safety instructions listed in this Manual.

Chart of recommended methods of operation is placed together with the basic set of tools on the machine. See chapter 11.24 Tools.

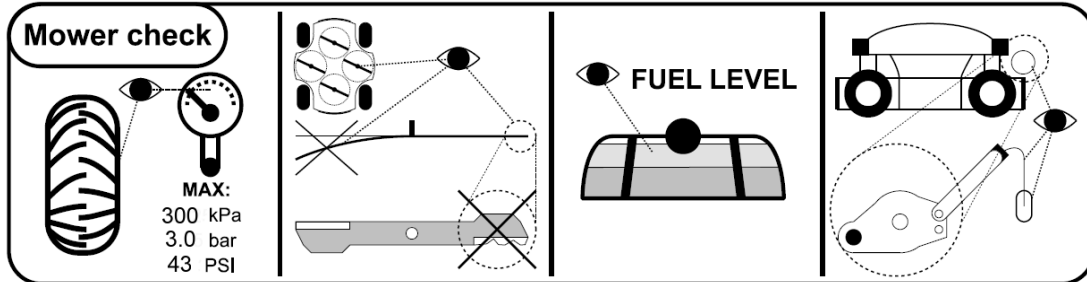

Always keep the tyres inflated to the recommended pressure. Other values may unfavourably influence the driving characteristics. Maximum pressure – 300kPa/3,0bar/43PSI

Check the blades. Blades must be properly tightened. Blades must not be bent and the edges must not be damaged.

Check the fuel level

Check the overall condition of the winch. The rope and the snap hook must not be damaged.

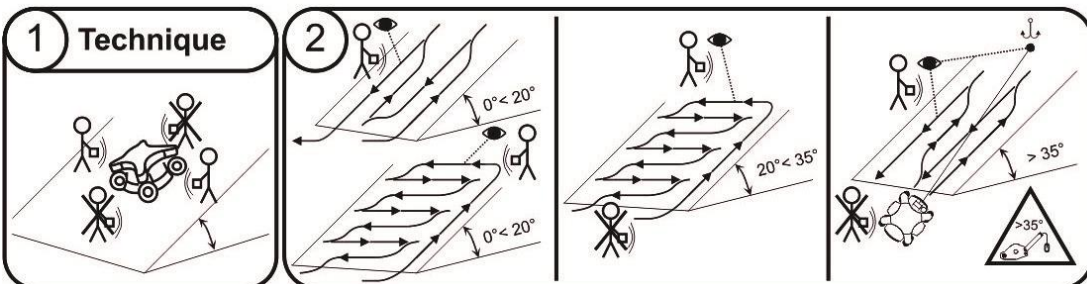

On slopes never enter the area below or directly above the machine.

Recommended method of cutting on slopes up to 36 degrees provided the operator is well acquainted with the terrain and there is no risk of tipping the machine over.

Recommended method of cutting on slopes up to 35 degrees provided the operator is well acquainted with the terrain and there is no risk of tipping the machine over.

On slopes exceeding 36 degrees always use the stabilizing winch. On slopes never enter the area below or directly above the machine.

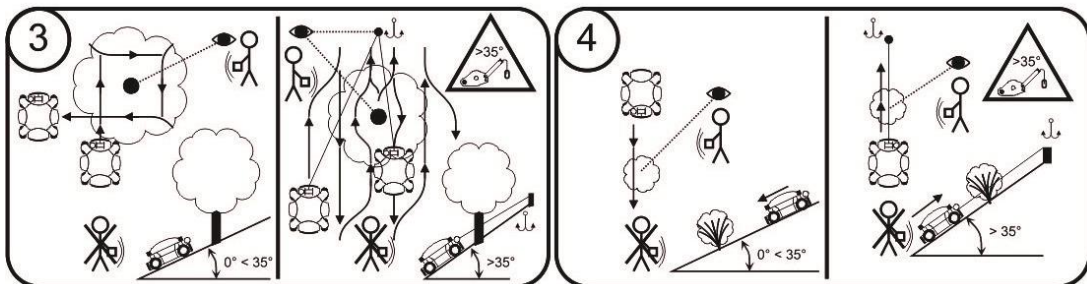

Recommended method of cutting around trees on slopes up to 36 degrees.

Recommended method of cutting around trees on slopes exceeding 36 degrees. On slopes exceeding 36 degrees always use the stabilizing winch.

Recommended method of cutting bushes on slopes up to 36 degrees.

Recommended method of cutting bushes on slopes exceeding 36 degrees. On slopes exceeding 36 degrees always use the stabilizing winch.

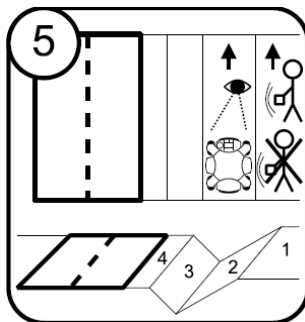

Recommended method of cutting along roads. Never enter the area below or directly above the machine. Danger of getting injured by objects thrown by the blades. Carefully check the terrain in front of the mower.

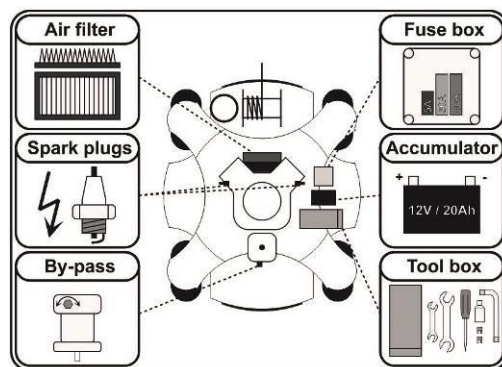

Position of important components on the machine (air filter, spark plugs, hydraulic by-pass allowing the disengagement of hydraulics and consequent towing of the machine, fuse box, battery, tools)

Instructions for turning on and off the hydrostatic winch

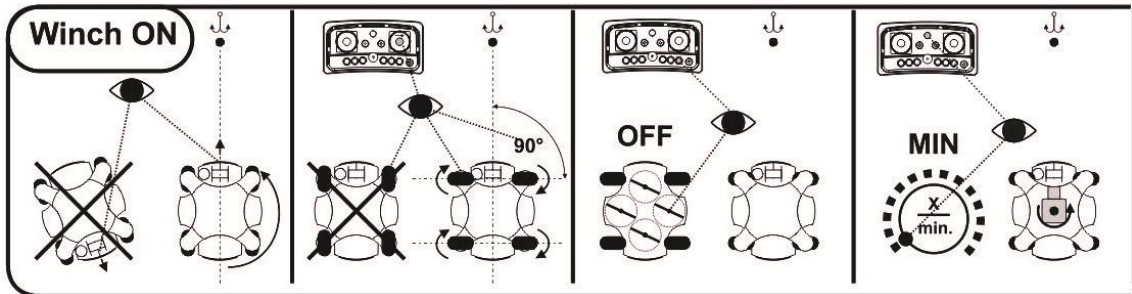

Winch ON
 Rotate the machine so that the winch is facing up the hill toward the expected anchoring point.
 Turn the wheels so that they are orientated across the slope (along the slope contours)
 Turn off the blades
 Reduce the engine RPM to minimum (idling speed)

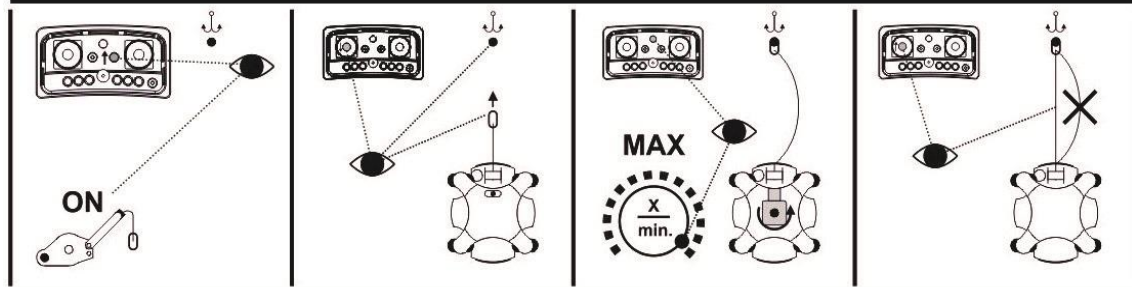

On the remote controller of the machine turn on the hydrostatic winch by the ON-OFF switch.
 By pushing the driving joystick slightly backward the rope will begin to unwind. Fasten the rope properly to the anchoring point.
 Increase the engine RPM to maximum
 Tighten the winch rope by pushing the driving joystick slightly in the forward direction.

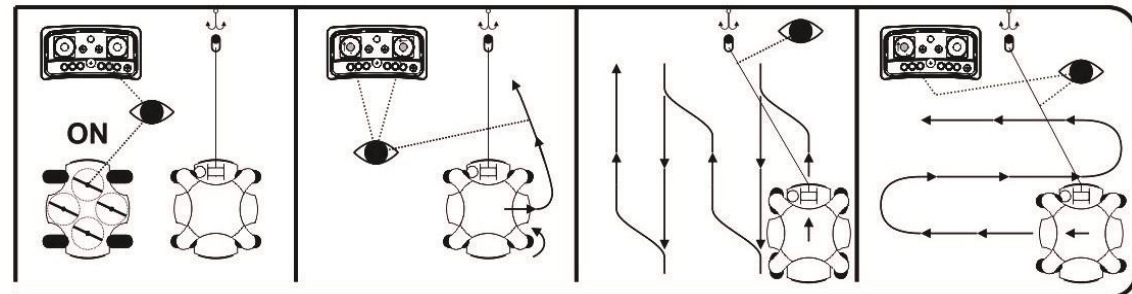

Turn on the blades
 Leave the anchoring position of the mower by pushing the driving joystick forward and by driving up the slope.
 Method of cutting up and down a slope: driving up the slope – push the joystick forward, driving down the slope – push the joystick backward
 Method of cutting across the slope: Drive according to the picture. The joystick should always be pushed in the forward direction..

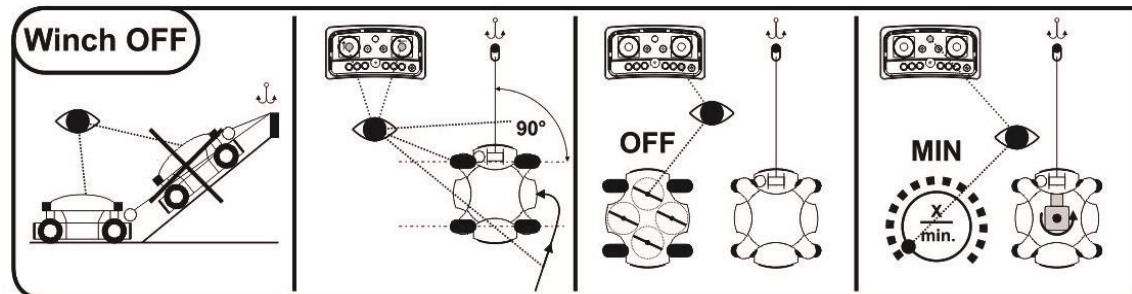

Winch OFF
 Place the mower at the bottom of the slope
 Turn the wheels across the slope, perpendicular to the anchoring point
 Turn off the blades
 Reduce the engine RPM to minimum (idling speed)

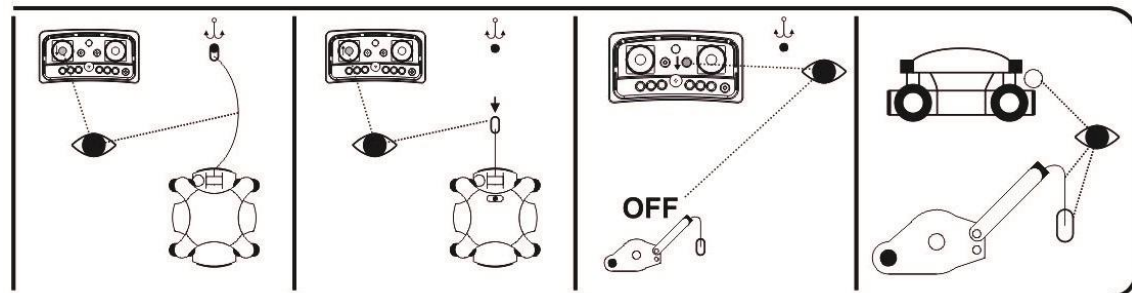

Loosen the winch rope by pushing the drive joystick slightly backward.
 Untie the rope from the anchoring point. Wind the rope back onto the winch drum by pushing the drive joystick slightly forward.
 On the remote controller of the machine turn off the hydrostatic winch by the ON-OFF switch.
 Check the overall condition of the winch. The rope and the snap hook must not be damaged.

6 CONTROLS

6.1 REMOTE RADIO CONTROLLER NBB

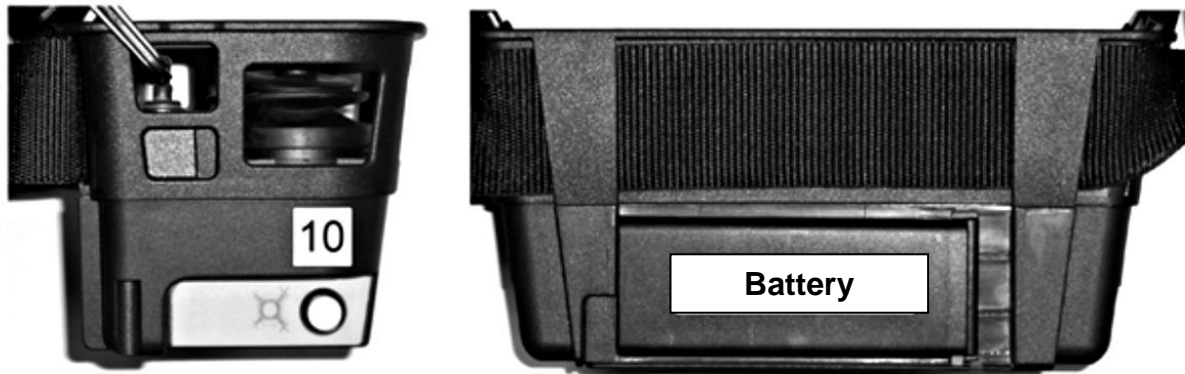
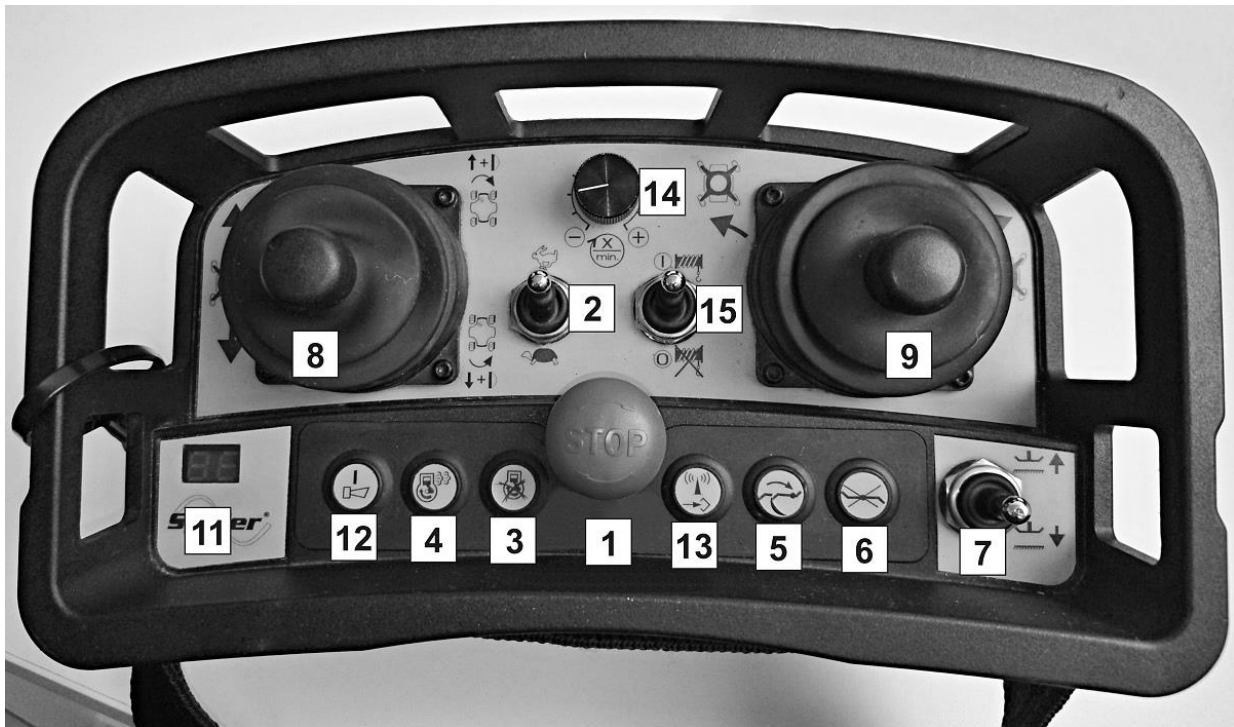

- 1 Main Switch / EMERGENCY STOP button
- 2 Driving speed controller H/L
- 3 Engine stop switch
- 4 Engine starter switch
- 5 Mowing blades ON switch
- 6 Mowing blades OFF switch
- 7 Height of cut adjustment
- 8 Joystick for driving forward / backward
- 9 Joystick for steering left / right
- 10 Skid steering switch
- 11 Remote controller power display
- 12 Operator's preparedness confirmation / Horn
- 13 Frequency check / change button
- 14 Engine speed controller
- 15 Winch switch On/Off

6.2 MOWER CONTROLS

On the body of the mower there are two controls for operating the mower. Additional controls may be added in case of attaching optional accessories. The function of controls pertaining to these accessories is explained in the user's manuals of these devices.



- 1 Lockable EMERGENCY STOP button / Ignition switch
- 2 Choke for cold start

7 DISPLAYS

7.1 NBB RADIO CONTROLLED DISPLAYS

Indicator (11) flashes – RC power ON indicator

Radio control emits a high pitch tone - RC battery low voltage warning

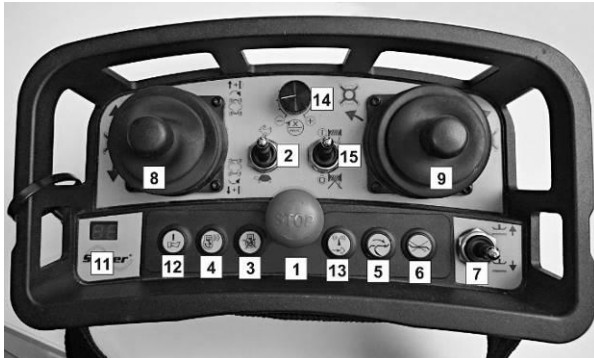

7.2 MOWER DISPLAYS

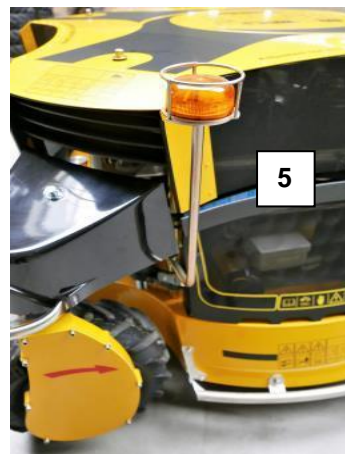
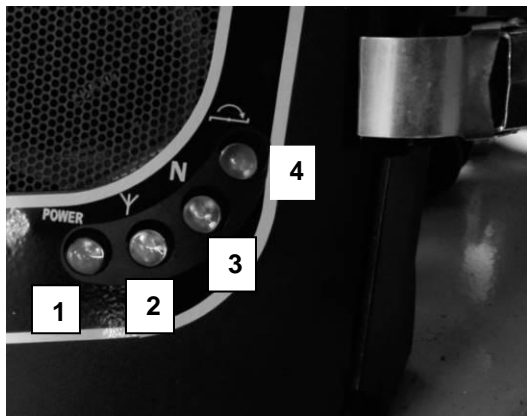

1. Power indicator
2. Signal reception
3. Neutral
4. Blade

5. Beacon

On the side cover of the mower there are a number of warning and indicating LEDs. These displays signal the following states:

- | | |
|-----------------------------|--|
| 1. Power indicator: | Illuminated green when the EMERGENCY STOP button on the top of the mower is unlocked |
| 2. Signal reception: | Illuminated green when the radio link between the RC and the receiver is established and correct |
| 3. Neutral: | Illuminated green when the transmission is in the neutral position |
| 4. Blade: | Illuminated red when the blades are engaged. |
| 5. Beacon: | flashing when the EMERGENCY STOP button on the top of the mower is unlocked |

- After the power supply is turned on, indicator lamp 1 will be illuminated
- After turning on RC and establishing communication between the RC and the machine lamp 2 flashes. If there is a break in communication, lamp 2 dims.
- Lamp 3 is illuminated when the drive servomotor is in a neutral position.
- Lamp 4 is illuminated while the blades are engaged. The mower cannot be started while this lamp is illuminated.

8 SAFETY SYSTEMS

8.1 MOWER SAFETY SYSTEMS

The product is controlled by a remote radio controller. This means that the operator is not close to the mower at all times and cannot use controls on the mower. For the safety of the operator and other persons the following table lists various situations and actions:

The mower is out of signal range	The EMERGENCY STOP command is automatically generated
Radio signal failure	The EMERGENCY STOP command is automatically generated
Another machine with the same frequency is working in the vicinity	The EMERGENCY STOP command is automatically generated
Emergency situations - shutting off by the EMERGENCY STOP button	Push the EMERGENCY STOP button on the radio controller
	Push the EMERGENCY STOP button on the body of the mower
Safety interlocks prevent the engine from starting.	If the mowing blade clutch is engaged
	If the transmission is not set to neutral position
	If the radio connection is not established properly

The EMERGENCY STOP command (automatic or manual) has the following effects:

1. Engine stops
2. Steering of wheels is blocked
3. Travelling is blocked
4. Starter is blocked
5. Mowing blade clutch disengages
6. Ignition is turned off

9. PREPARING THE MACHINE

9.1 MACHINE DELIVERY TO A DEALER OR RETAILER



From the manufacturer the machine is delivered filled with engine oil and Hydraulic oil but without gasoline in the tank.

The training of the operator should take place during the installation of the product.

The mower may be delivered on a wooden pallet or in a crate.

To take the mower off the pallet/crate:

- Place the palette with the mower on a level surface
- Carefully remove the upper boards of the crate and take out all accessories & the remote control. Disassemble the side boards of the crate
- Release the attachment fastening the mower to the pallet, remove transportation wrapping. Recycle these wraps.
- Thoroughly examine the mower for possible damage and missing parts from the delivery. If necessary, contact the transporting company with your claim.
- Before driving down from the pallet raise the mowing mechanism to the upper position (this can be done without starting the engine)
- Place boards in front of the wheels in the direction, in which you expect to drive the mower from the pallet to the ground. Put at least 5 litres/1.2 gallon of fuel to the tank and attach cables onto the battery. While starting, follow instructions in chapter 5.
- The aerial must be attached to the mower
- After starting the engine set the speed controller on the transmitter to the (L)/turtle symbol – lower driving speed
- Slowly move the forward/reverse joystick to correspond with the direction you want to move the mower. The arrow on the wheel legs indicates forward.
- Slowly drive down to the ground and stop the engine
- While unpacking, assembling and preparing the mower, do not engage the mower blade.

NOTICE: if you have a lifting device with a sufficient lifting capacity available, place the lifting hooks/eyes on spots marked with the symbols of chain, lift the load by about 0.15 m / 6 inches, move the pallet away from the mower and lower the machine to the ground.

NOTICE: There may not be enough fuel in the fuel system when starting for the first time and you may need to repeat the starting several times. Starting period must not exceed 3 seconds. There must be a pause of at least 20 seconds between all attempts to start the engine.

Parts of delivery:

- SPIDER mower
- Mower ignition key (2×)
- Gel battery (12V starting)
- Remote control including 2 batteries
- Remote control battery charger (12V – 7.2V)
- Operation manual
- Radio controller key (2×)
- Engine user's and maintenance manual
- Copy of the EC declaration of conformity
- Copy of the EC declaration of conformity for Remote controller NBB

9.2 HYDRAULIC PUMP BY-PASS

The By-pass is used to disable the hydraulic drive and to engage the oil bypass for manual handling (engine not running) of the machine on flat surfaces. The by-pass should only be used when the hydraulic drive is not functional. For normal hydraulic drive it is necessary to have the bolt on the pump tightened. For manual handling loosen this bolt by two revolutions.

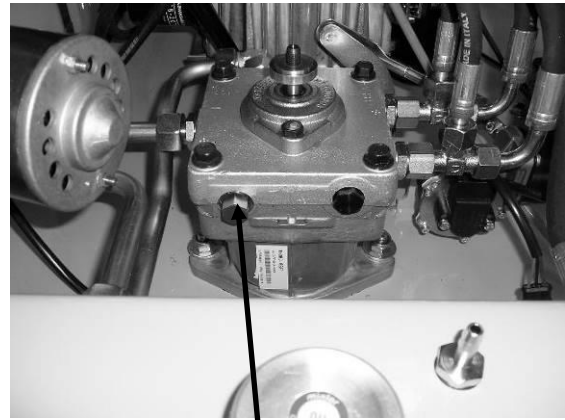

BY-PASS



Before starting, check the bolt tightness. If loose, it will disable the hydraulic drive.



Insufficient tightening may result in undesirable behaviour of the mower on slopes. It may uncontrollably drive down a slope

9.3 CHECKING ENGINE OIL LEVEL



Attention! Before checking or refilling oil stop the engine and let it cool down.

The oil level of the machine standing on a level surface must be between the limit marks on the dipstick (see the engine user's manual). Check oil according to the engine user's manual as follows:

- 1) Place the machine on a level surface.
- 2) Unscrew the dipstick (next to fuel tank funnel) and wipe off oil.
- 3) Without screwing insert the dipstick back into the filler as far as you can.
- 4) If the oil level is close or under the lower limit mark (Min), fill with recommended oil up to the upper limit mark (Max).
- 5) Refit the dipstick.

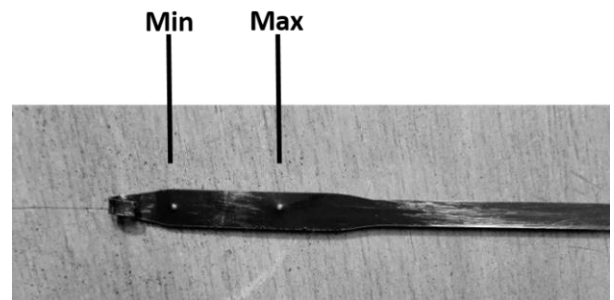

NOTICE:

Running the engine with insufficient oil may cause serious damage to the engine.



Check the engine oil level on a level surface and only when the engine is off. Use only oil recommended by the engine manufacturer (see 11.4).

9.4 CHECKING HYDRAULIC DRIVE OIL LEVEL

Oil level should only be checked when the oil is cold.

Clear debris from around the cap; unscrew the cap on the hydraulic oil tank on the side of the mower.

Using the dipstick check the oil level. It must be between the limit marks.

If the level is above this range, the oil may overflow from the breather pipe in the tank when hot. If the level is below the lower limit, the hydraulic drive may be damaged or the mower may become uncontrollable when operating on a slope.

Refill with oil if necessary (HV 68 according to ISO 6743 or HLP 68, CLP 68 according to DIN 51502)

When finished, refit the cap back on the oil tank

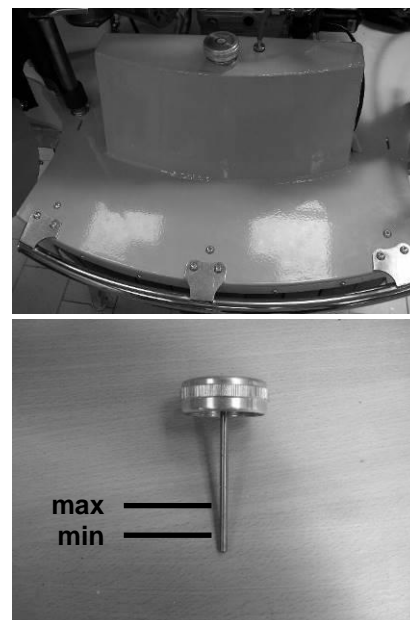

9.5 PREPARING THE BATTERY

SPIDER 2SGS uses a gel battery model 6E12, 12V, 18Ah

NOTICE:



Do not fill the battery with electrolyte. The machine construction uses a dry type of battery. If recharging, use a maximum electric current of 1.4 A.

- Loosen safety clips (A) and remove the side cover (see figure).
- Insert the battery
- Attach terminal connectors according to polarity. First (+), then (-).
- Secure the battery against movement with a rubber band.
- Attach back the side cover.
- When disconnecting and removing the battery, proceed in reversed order.



Never start the mower when a charger is connected to the battery.
FOR CHARGING USE ONLY SPECIAL CHARGERS PREVENTING THE EXCESS OF THE GASSING VOLTAGE.
WHEN CHARGING THE BATTERY, MAKE SURE THAT CABLES CONNECTING THE BATTERY TO THE MOWER ARE DISCONNECTED.

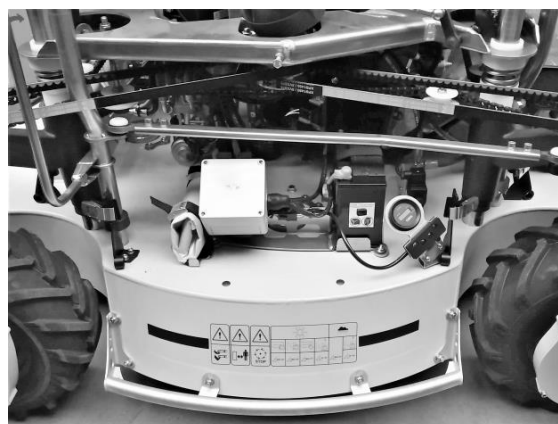

9.6 FUEL TANK

The fuel tank is placed on the frame on one side of the mower. The tank has a screw-on cap A.

Before refuelling always stop the engine. Do not smoke or approach open flames or sources of sparks when manipulating with gasoline.

Use unleaded 95-octane gasoline without any additives. The operator is responsible for all engine or fuel system damage resulting from the use of wrong, low-class, old or contaminated fuel. The warranty does not extend to such damage.

Do not fill the tank near open flames or sources of ignition. Do not smoke.

Do not open the tank while it is hot.

Do not fill/empty the tank in enclosed areas.

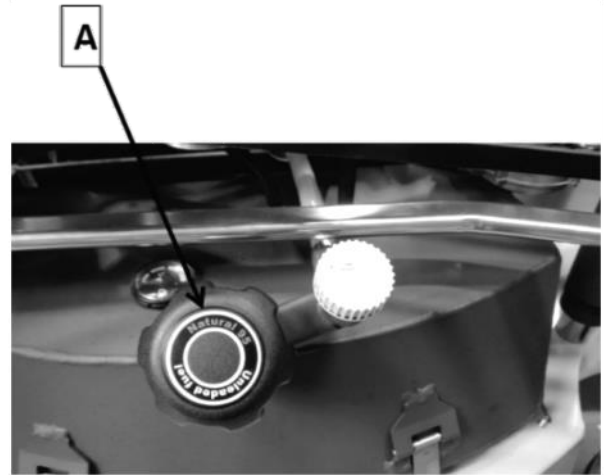

9.7 PREPARING THE NBB REMOTE RADIO CONTROLLER

Insert the original battery (Ni-Cd 7.2V, 1500 mAh) into the remote radio controller. If the power indicator flashes, the battery is charged.

If the remote radio controller battery voltage is below the required level, the entire machine will turn off automatically.

Discharge signal – if the voltage of the remote radio controller is too low, then the RC will emit a high pitch sound.

Move the mower to a safe place and replace the battery. After the low voltage is indicated, you have about 15 minutes to move the mower to a safe place. After 15 minutes the remote radio controller will be turned off permanently.

9.8 CHARGING THE NBB REMOTE RADIO CONTROLLER BATTERY

To charge the battery:

- Connect the charger to the electric power outlet in your car.
- Insert the battery into the charger (orange lamp is illuminated, and the battery charging starts).
- When the battery is fully charged, the orange lamp flashes quickly.

Leave the battery in the charger as long as necessary (the charger controls the charge level and does not overcharge the battery).

If the battery is exhausted, replace it with a reserve battery



The transmitter (remote radio controller) and the receiver (control unit) were adjusted and set-up by the manufacturer. Do not make any modifications to these devices. They are a matched pair.

10 OPERATION

10.1 TRANSPORTING THE MOWER

The mower should be transported to the mowing area on a trailer or other suitable transport vehicle.

Transporting the mower on thoroughfares on its own wheels is prohibited

When loading/unloading a trailer, make sure that the edge - formed by the floor of the trailer and the ramps – is not an obstacle for the mower. Otherwise you need to use longer ramps.

When loading, do not allow any person to stand by the ramps or under the hanging mower if it is lifted. It may only be hung up on places marked by the chain symbol. The loading capacity of the lifting eyes/hooks must be suitable for the weight of the machine as quoted on the serial plate.

When transporting the mower, make sure it is properly secured. Attach fastening devices to the eyes marked by the chain symbol on the mower.

10.2. STARTING THE ENGINE OF THE MOWER

- Check the gasoline in the fuel tank; refuel with unleaded gasoline BA95 if necessary.
- Check the forward/reverse control joystick (8) on the remote radio controller and leave in the neutral position.
- Switch ON the remote radio controller power switch (1) by turning clockwise. A red lamp (11) will illuminate on the RC.



NOTICE:

Unless button (1) is in the ON position, the machine will not start

Ensure the EMERGENCY STOP button (1) on the remote radio control is in the raised position.

Use the key to unlock and pull up the EMERGENCY STOP button on the mower.

Set the engine choke control to the position for cold start - the lever is pulled up (only for the first start or if the engine is cold). See the engine user's manual.

Wait till lamps 1 and 3 are illuminated and lamp 2 is flashing (on the mower), then press the horn button (12) on the remote radio controller – the mower ignition engages.

Press the START button (4) on the remote radio controller. If the engine does not start, all the functions of the mower are locked again. To unlock them and consequently to start the engine, press button (3). After three unsuccessful starting cycles machine is locked, wait for one minute.

The engine is “running”, release the START button on the remote radio controller. While the engine is working do not use the START button again.

Let the mower idle for about 2 – 3 minutes without engaging the mowing device and, while the engine is warming up, push back the choke control (in the case of a cold start).



NOTICE: Do not stand in direction where the mower may move while starting it

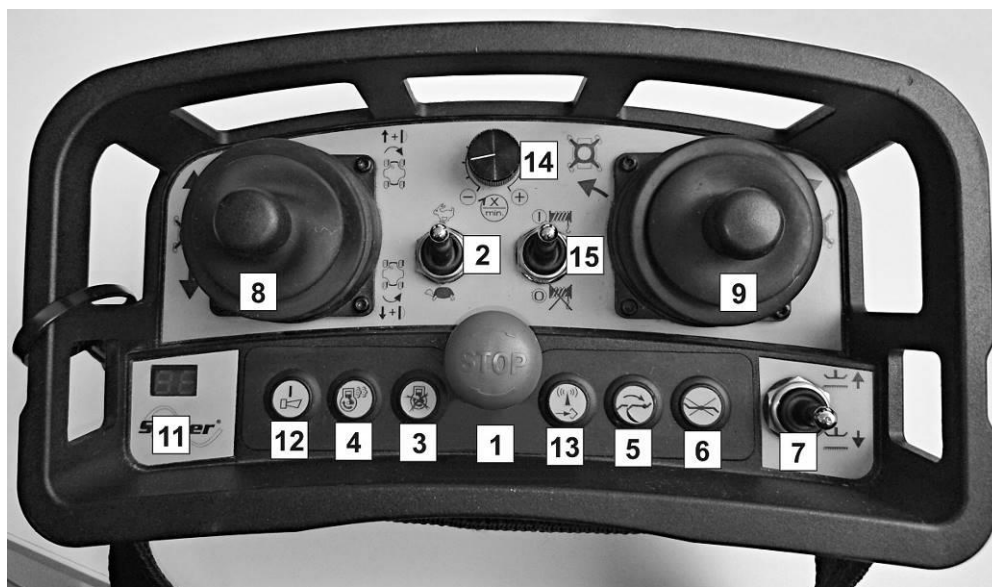

10.3 SHUTTING OFF THE ENGINE

Before shutting off the engine, always disengage the mowing mechanism drive on the remote radio controller.

Do not shut the engine off immediately after mowing; let it run for a short while with the minimum engine speed in order to let it cool down

Stop the engine by pushing the STOP button (3) on remote radio controller.

Do not use the EMERGENCY STOP button to shut off the engine except in an emergency.

Press the EMERGENCY STOP button on the mower and remove the key

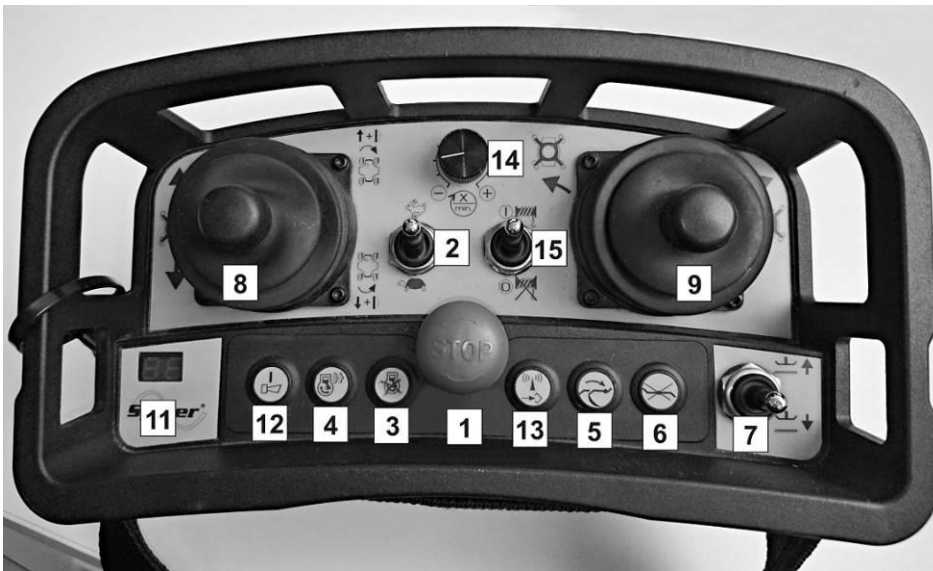
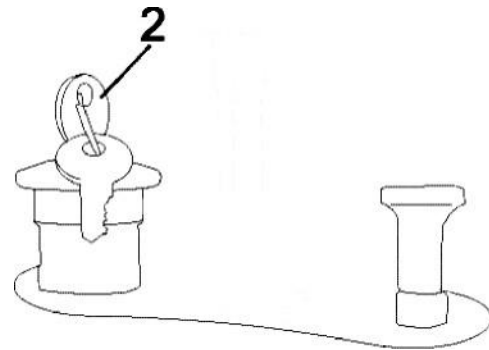

10.4 EMERGENCY SHUTTING OFF OF THE ENGINE

There are two red EMERGENCY STOP buttons. One is placed in the remote radio controller (1), the other one on the body of the mower (2). Both buttons have the same function.



For emergency stopping use preferably the remote control button (1). Use the button on the mower (2) only when the mower is in a stable position and on a flat area, or when you are standing right next to the mower and you cannot be endangered by the machine.



The EMERGENCY STOP buttons on the remote radio control (1) and on the mower (2) should be used at any time when an emergency stop is required.

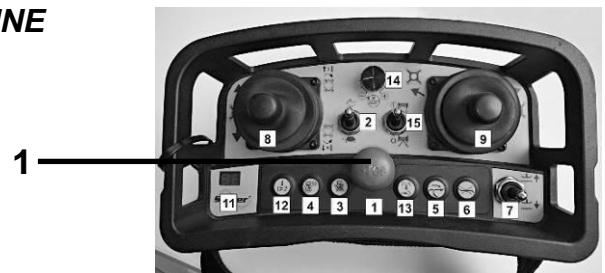

10.5 ENGAGING THE BLADES

The mowing blades can only be engaged when the engine is running.

Set the maximum mowing height with controller (7).

First increase the engine speed by regulator (14), then push the button for blades engagement (5) – the mowing device turns on. Set the working position of the blade by the height of cut controller (7) on the RC.



NOTICE:

Do not engage the mowing blades in tall grass, damage to the clutch may result. If you wish to mow tall grass, move the mower to a place without tall grass and then turn the blades on. When engaging the blades stand in a safe distance from the mower. Do not engage the blades if there are people near the mower. The rotating blades may throw objects.

10.6 DISENGAGING THE BLADES

To disengage blades, press button (6). If you are not planning to continue mowing, set the maximum height of cut with controller (7).

10.7 HEIGHT OF CUT ADJUSTMENT

The machine has a variable mowing height. As a standard the height of cut can be adjusted from 90 to 140 mm / 3.5 to 5.5 inch (70-120 mm).

The mowing height can be adjusted by switch (7) on the RC. Follow the marks on the body of the mower.

If the grass growth is high or wet, select a higher mowing position

The lowest position is used when mowing well-maintained and even areas.



NOTICE:

When mowing unknown areas for the first time, we recommend to mow with blades in a higher position and - after finishing mowing - to re-examine the area for undesirable objects. The next cut should only be done after the grass cuttings have dried up.

Set an approximate height of cut, mow a few meters of the area and check that the height of the cut grass meets your expectations.

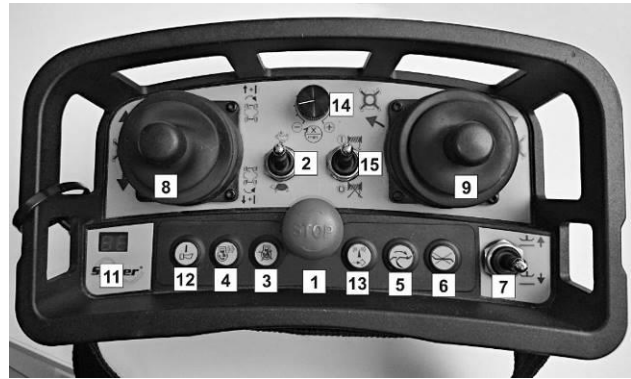

NOTICE:

The height of cut on a slope may significantly vary from that on a level surface.



NOTICE:

Switch 7 has 3 positions: The maximum and minimum limit position and the third intermediate position, which preserves the current height set-up.

Cleaning the mowing mechanism

After each use the mowing mechanism must be carefully cleaned, especially the inner walls of the mowing deck. The cleaning should be carried out with a scraper. The mower must not be washed by power washer or other high-pressure devices. When cleaning, secure the machine against moving.

Raise the mowing mechanism to the transporting position. When cleaning, also check the blades. Proper maintenance and treatment of the mowing mechanism increases the quality of work and durability of your machine.

After cleaning and drying, especially if the mower will not be used for a longer time, treat all scratched parts with preservative coating.



If you are lifting the mower during cleaning, make sure that you secure it against movement and fall.

Disconnect the battery, remove the spark plug terminal and press the EMERGENCY STOP button on the mower.

10.8 ENGAGING THE WINCH

To work with stabilize winch switch button (15) into ON position.

For instruction how to use stabilizing winch please refer to "Winch Operation Manual".

10.9 DRIVING THE MACHINE

The machine movement is controlled by joystick (8) (forward and reverse) (see the symbol under the joystick on the remote radio controller) and by joystick (9) (Left/right). By combining these two controls you will be able to control the machine. When these joysticks are moved, the machine both accelerates and steers.



NOTICE:

Accelerate slowly so as to be able to react to the direction in which the mower starts to move. The V shaped tread pattern on the tyres denotes the direction the machine will move when forward motion is selected.

When driving, slowly move the joystick in the desired forward or reverse direction.

When changing the forward motion to reverse motion and the other way around, always leave the joystick for a short moment in the neutral position.



When driving the mower, always set the maximum engine speed. Driving with any lower engine speed is prohibited.

In cold weather let the engine run for about 2 minutes to allow the oil to get warm before driving.

10.10 DRIVING SPEED OF THE MOWER

Always choose a suitable driving speed, which enables an acceptable mowing quality. When selecting speed, always start with slow and proceed to fast, not the other way around. If the growth is thin, you may mow at higher speed.



To control the driving speed, you can also use the driving speed controller (2), which lets you choose between high (rabbit) and low (turtle) driving speeds. When starting to operate, always use the low (turtle) speed range. Also choose the low speed range when mowing either slopes steeper than 20 degrees or an uneven terrain.



Never reduce the driving speed by reducing the engine speed! Always use joystick (8) to reduce the speed.

Higher speed range: 0-8 km.h¹ / 0-5 mph
Lower speed range: 0-3 km.h¹ / 0-2 mph



IT IS PROHIBITED to drive on slopes steeper than 20 degrees with the mowing device engaged and the controller switched to the high-speed (rabbit) position.

IT IS PROHIBITED to switch to the high or low speed position while mowing. Stop the machine before selecting a different speed range.

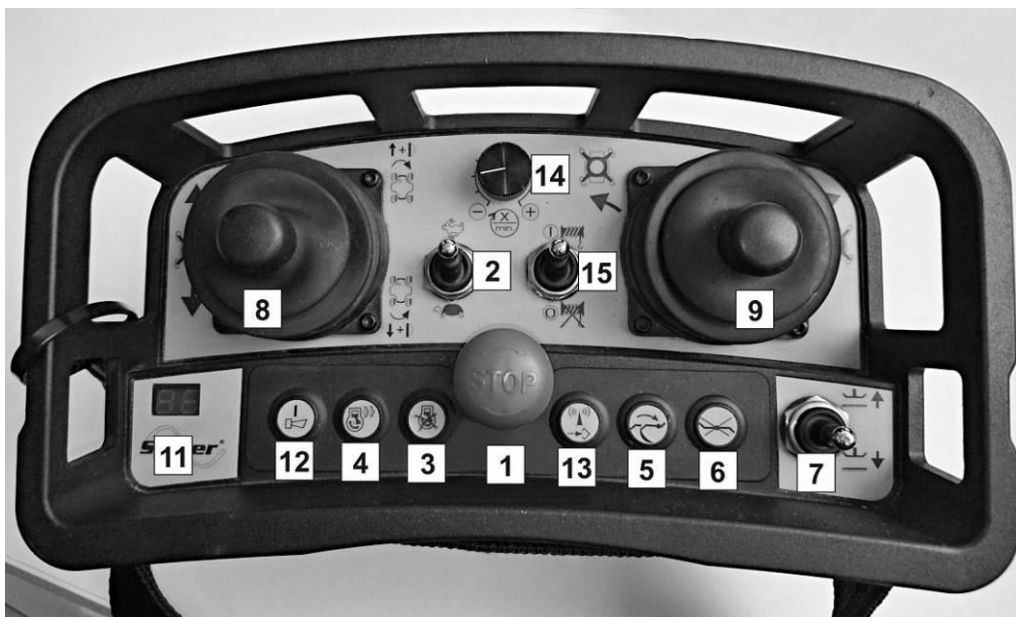

10.11 DRIVING ON SLOPES

Driving on slopes is very demanding for the operator, as they constantly have to evaluate information about the movement of machine and the character of the terrain. Especially important is the wheel adhesion to the grass or other surface and the mower tilt angle.

Pay attention to climatic conditions.

The climbing ability of the mower will be radically different on dry, wet or moist grass slopes.



The mower may work on the recommended slopes (see chapter 2.2) only when the surface (grass) is dry. If the grass is wet or moist, the maximum slope, on which work is permitted, is 20 degrees without use of the integrated stabilizing winch, when using the integrated stabilizing winch the climbing ability is up to 55 degrees.

Examine the working area closely. Evaluate the situation and test the possibilities and characteristics of the specific terrain. Do not take chances. If the mower loses traction, you have lost control, stop mowing and re-evaluate the conditions.

The driving wheels of the mower should be evenly inflated to the maximum value allowed by manufacturer 300 kPa / 3,0 bar / 43 PSI.

Preferably start your work at the bottom of the slope and proceed to the top. This way you will be usually moving from less to more steep slopes, which will give you a better chance to evaluate the climbing ability and make the right decisions concerning further work. If you begin to mow steeper slopes first, it may happen that – due to adverse conditions - the mower will slip on the slope. Due to dynamic effects the mower may even roll over. The method of cutting from the top of the hill to the bottom should only be used exceptionally when the operator is in detail acquainted with the terrain.

If the mower is slipping, do not try to stop it and do not approach it, especially the area below or directly above the mower.

Do not touch or approach the mower if the wheels are lifted, the mower tilted, in an unstable position or starting to roll over.



Before operating on slopes, make sure that no one is below the mower or the working area. Do not endanger third persons by the movement of the mower.

Choose your operating position away from the area to which the mower may slide or to which the mowed grass may be thrown. The direction of the discharged grass may change while operating according to the driving direction of the mower.

When working on slopes, avoid the following:

- Sudden sharp acceleration, steering or braking
- High driving speed
- Uneven ground
- Changing adhesion (moving from areas exposed to sun to shade)
- Driving over the mowed material
- Reduction of engine speed
- Stopping on a slope and shutting off the engine.

10.12 STOPPING THE MACHINE ON A SLOPE

In case you are forced to stop the mower on a slope and need to interrupt your work, stop the engine etc. be sure to position the wheels across the slope. This will prevent possible movement of the mower down the slope.

10.13 SKID STEERING

Slope mower Spider 2SGS is equipped with skid steering function. This function allows machine rotation around its vertical axis by driving wheels in opposite directions. This function can be activated by controller 10 under the condition that the wheels are positioned in the straight direction (see the figure below). If these conditions are met then the mower can be rotated using controller 8 (driving forward/backward). By moving the joystick forward the mower rotates clockwise, by moving it backwards the mower rotates counter clockwise.

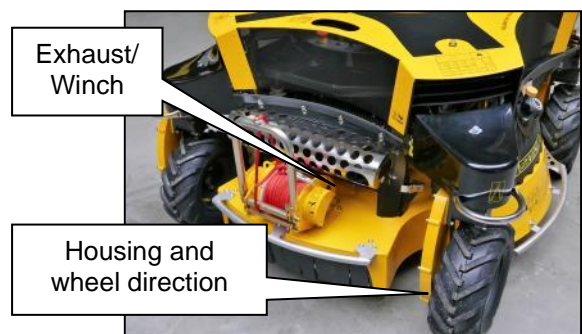

11 MAINTENANCE AND LUBRICATION

11.1 MAINTENANCE CHART - MOWER

Machine Maintenance Plan					
Period according to the state of the operating hours (OH)	X = Operator	Daily before operating	Every 50 OH	Every 200 OH	Every 400 OH
Visually check for oil leakage from engine and hydraulic systems		X		X	
Grease all sliding bars (at least once a season)			X		
Lubricate other lubrication points with dry lubricant in a spray			X	X	
Check the level of hydraulic oil in tank		X		X	
Check the tyre pressure		X		X	
Visually check the tension of travel V-belts		X		X	
Visually check the tension of the steering chain		X		X	
Check the remote control battery state of charge		X			
Check the mower battery state of charge		X			
Check electronic and safety devices (emergency stop, steering, signal etc.)		X		X	
Check screw and nuts tightening (visually check daily)				X	
Check blade sharpness and deformation		X		X	
Check the blade bolts tightening		X			
Change the hydraulic oil (first exchange after 200 OH)					X*
Change the hydraulics filter (first exchange after 200 OH)					X*
Rinse the fuel tank, change the breather filter					X
Change the fuel filter (change more often on extremely dusty or dirty conditions)					X
Clean cooling systems (engine, hydraulic pump)		X			
Visually check hydraulic hoses, fuel hoses, cables – replace if necessary					X
Check and adjust wheel geometry				X	
Adjust the neutral position of the machine drive (hydraulic pump)				X	
Check, adjust and tighten chains in the wheel suspensions				X	
Adjust the blade deceleration				X	
Check drive belts and mowing mechanism belts – replace if necessary				X	
Check and clean the mowing mechanism gear (belts, pulleys, belts pulleys)			X		
Check safety decals on the machine		X			
Check the mowing device bearings				X	
Check the blade hub				X	
Check the Brake lining condition		X			
Adjustment of the auxiliary drive brake by an authorized service facility				X	

* No later than 2 years

11.2 MAINTENANCE CHART – ENGINE

Engine maintenance chart: Kawasaki FS691V 21 HP							
Maintenance	Period according to the operating hours counter						
	Daily	After first 8 hours	Every 25 hours	Every 50 hours	Every 100 hours	Every 200 hours	Every 300 hours
* = Perform more often in dusty conditions K = Performed by authorized Kawasaki service/dealer							
Check and add engine oil	X						
Check for loose or lost nuts and screws	X						
Check for fuel and oil leakage	X						
Check or clear air intake screen	X						
* Clean air cleaner foam element	X						
* Clean air cleaner paper element	X						
* Clean dust and dirt from cylinder and cylinder head fins					X		
Tighten nuts and screws					X		
Change engine oil		X			X		
Clean and set spark plug					X		
Change oil filter					X		
* Replace air cleaner paper element						X	
K Clean combustion chamber							X
K Check and adjust valve clearance							X
K Clean and lap valve seating surface							X
	= Device check						
	= Element replacement						

Engine oil requirement may differ according to the use in different seasons or climatic zones. The following chart shows the SAE values

Chart of SAE oil classes according to external temperatures engine

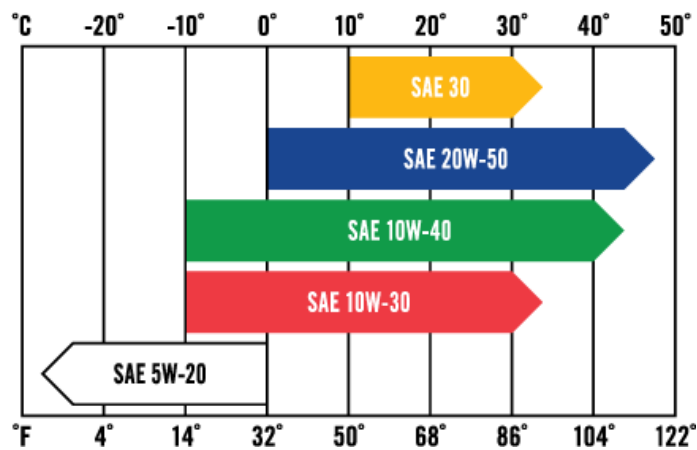

Recommended oils:

SAE 10W – 40 API classification SF or higher
 For higher working temperatures we recommend SAE 20W-50

11.3 ENGINE MAINTENANCE

NOTICE:



The following activities are considered to be workshop maintenance and should be carried out by trained personnel.

Before beginning any maintenance activity on the mower, turn off the engine, push the emergency button and remove the key from the button. Also turn off the remote radio controller by the switch on the control panel.

To eliminate the possibility of an unexpected start of the mower, disconnect the (+) terminal connector on the battery.

The engine should only be repaired or serviced by an authorised dealer/servicing facility that possesses all necessary tools, equipment, spare parts and professional skills.

When maintaining, repairing or cleaning, always follow the engine manufacturer's user's manual, which is included in the technical manual pack.

11.4 CHANGE THE ENGINE OIL

Period of change find in Maintenance chart of engine (see 11.2)

Change the oil while the engine is still warm, but not hot.

- Remove the side cover of the fuel tank.
- Detach the oil drain hose from the clip.
- Unscrew and remove the oil drain cap. Carefully lower the oil drain hose into an approved container and allow the oil to drain out.
- Fit the oil drain cap and secure the oil drain hose back to the clip.
- Pour in the fresh engine oil and check the engine oil level.
- Run the engine, check the oil level again and top up if necessary.

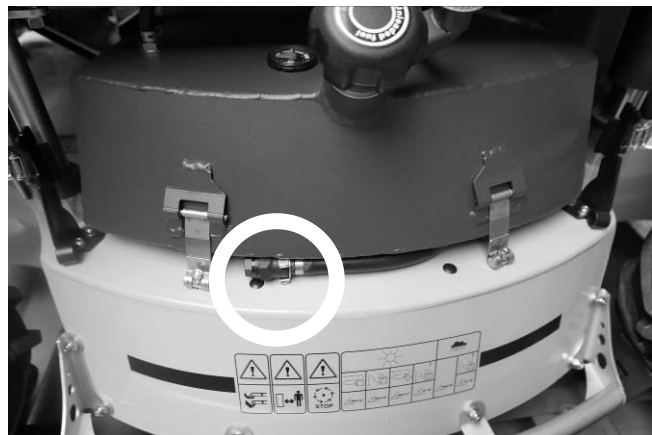

11.5 CLEANING THE FUEL TANK

While using the mower impurities may settle in the fuel tank. These impurities may cause a blockage while using the mower.

The fuel tank may only be emptied by siphoning the gasoline from the tank, especially if it is full.

The filter hose from the fuel tank leads under the upper part of the body to the filter. Blocking may be identified by poor engine performance and by vacuum being created in the tank.



When working with gasoline do not smoke or work near open flames.

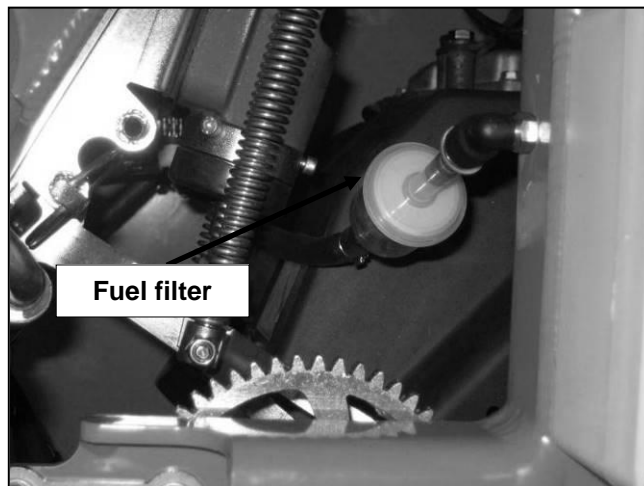

11.6 MAINTAINING THE HYDRAULIC DRIVE

The maintenance of the hydraulic drive requires properly trained service personnel.

Regular maintenance should address the torque of hydraulic connections and bolts, replacement of pressure hoses and oil refilling.

NOTICE:



The maintenance of the hydraulic parts must be carried out in a very clean working area. Any contamination brought into the hydraulic circuit may cause damage. If replacing any part, remove all contamination by rinsing it with cleaning fluid.

NOTICE:



The hydraulic drive must never work without or with an insufficient amount of oil, not even for a short time

11.8 ADJUSTMENT OF THE NEUTRAL POSITION OF THE HYDRAULIC DRIVE

Manual adjustment should only be performed by an authorised service/dealer.

11.7 CHECKING AND REFILLING OIL

Check the oil level in the hydraulic oil tank daily.

Measure the oil level with the dipstick in the cap of the tank. The oil level must be between the limit marks. If you are working in extreme conditions, the level of oil (at ambient temperature) must reach the upper limit mark on the dipstick.

When checking the oil, the engine must be off and the oil cold.

NOTICE:



If you are checking warm or hot oil, the level of oil may be higher (and reach above the limit mark) due to the oil volume expansion.

Do not overfill the hydraulic tank.



For Control Units S/N 96 001 xxxxx there is a possibility of neutral position adjustment by so called Teach mode allowing trimming of neutral position on Remote controller

<p>1) Activate the programming mode</p>	<p>Set all proportional channels to zero position.</p> <p>Release the EMERGENCY STOP switches and wait till the radio connection is present.</p> <p>Press and hold the “Motor Start” (4) and “Motor Stop” (3) buttons for 5 seconds.</p> <p>As a confirmation the horn will be activated briefly (2 times).</p> <p>Do NOT press the “HORN/ENABLE” (12) button!</p>
<p>2) Adjust the Zero Position value</p>	<p>Standard value is 0.</p> <p>Use steering joystick 9 for adjusting the value (left/right).</p> <p>Each time you push the steering joystick to the left, the value will decrease by one.</p> <p>Pushing the steering joystick to the right will increase the value by one.</p> <p>Each time you move the joystick to the left or right, the horn will acknowledge the movement.</p>
<p>3) Save the value</p>	<p>For saving the value after changing, you have to push the “HORN/ENABLE” (12) button.</p> <p>The values are stored now.</p>
<p>4) Check the values</p>	<p>Press the EMERGENCY STOP switches !!!ATTENTION!!! – press first the EMERGENCY STOP switch on the remote controller and after the mower’s EMERGENCY STOP switch (not in opposite order). Wait 2-3 seconds. Release the EMERGENCY STOP switches again and prepare the mower to operate by pressing the “HORN/ENABLE” (12) button.</p> <p>If you are not content and want to change the values again, start over at point 1.</p>
<p>Restore the factory settings / default value</p>	<p>Set all proportional channels to zero position. Release the EMERGENCY STOP switches. Wait till the radio connection is present.</p> <p>Press and hold the buttons for “Motor Start” (2) and “Frequency check/change” (13) for 5 seconds.</p> <p>The factory settings / default values are restored automatically.</p> <p>As a confirmation the horn will be activated briefly (4 times).</p> <p>Release the buttons. Press the EMERGENCY STOP switches !!!ATTENTION!!! – press first the EMERGENCY STOP switch on the remote controller and after the mower’s EMERGENCY STOP switch (not in opposite order). Wait 2 seconds. Release the EMERGENCY STOP switches again and prepare the mower to operate by pressing the “HORN/ENABLE” (12) button.</p>

11.9 DRIVE V-BELTS

Check the wear and tension of the V-belts and the tensioning devices.

a) *Hydraulic pump drive*

Located under the cutter deck inside cover (A).

The V-belt is tensioned by a belt pulley. To tighten the belt, dismount the belt pulley and remove the required number of spacers.

b) *Clutch belt*

Located under the cutter deck inside cover (A).

The V-belt is tensioned by a belt tensioner and a belt pulley. To tighten the belt, dismount the belt pulley and remove the required number of spacers.

c) *Travel wheels drive*

The V-belts are tensioned by shifting the hydraulic motors.

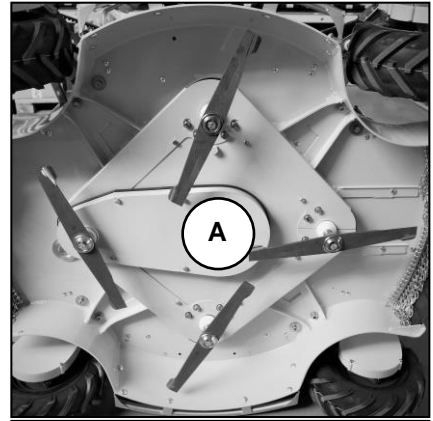

11.10 GEOMETRY ADJUSTMENT

If you do not possess necessary equipment and skills, have this work performed by an authorized service/dealer

- Lift the mower (wheels above ground) and position the wheels into a straight direction
- Release the steering chain taper lock
- Place a straight lath to the wheel portal on the left side and to the tyre disc on the right side and adjust the wheels so that they are parallel
- Tighten at least one screw of the taper lock (whichever is accessible). Do not turn the wheels unless you have tightened at least one screw - this would distort the geometry!
- After tightening one screw you can turn the wheels
- Tighter the second screw
- Check the geometry with a lath
- Step-by-step turn wheels and tighten both screws of the taper locks of all wheels until they are completely tightened (approx. 23 Nm)



11.11 FINAL GEAR DRIVE TO WHEELS

If you do not possess necessary equipment and skills, have this work performed by an authorized service/dealer.

Remove the cover of the final gear drive. The cover is attached by bolts onto the sides. Adjust the chain tensioner C so the chain is properly tensioned. The tensioner can be shifted after loosening the fastening screws (see the figure). To tighten the chain, slightly unscrew the thrust bolt.

Do not tension the chain excessively. This could reduce the durability of the chain and the bearing. Lubricate the chain by spraying it with lubricating oil.

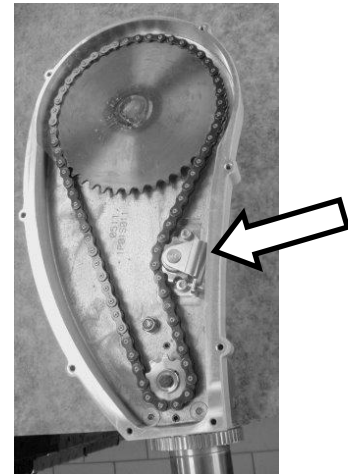

11.12 MAINTAINING ELECTRIC CIRCUITS AND DEVICES, TRANSMITTER

Keep all parts of electric circuits clean, especially from oil products, dust sediments and dry grass. Replace conductors with damaged insulation. For replacement use only original conductors supplied by the manufacturer.



NOTICE:

Repairing of electric circuit should only be performed by an approved dealer.

11.13 ADJUSTING BLADE DECELERATION

The electromagnetic clutch is placed under the clutch cover (A) above the rotary blades. The clutch was adjusted by the manufacturer. When engaged the clutch transmits power onto the blades, when disengaged the brake stops the rotating blades. Do not change the clutch setting. If damage on this part of the machine should occur, always leave the repairing to an approved dealer. The maximum rundown time of the rotary blade was set to 5 seconds.



NOTICE:

After finishing any work on the electromagnetic clutch, the cover must be returned to its original place and properly sealed to prevent the clutch from getting dirty.

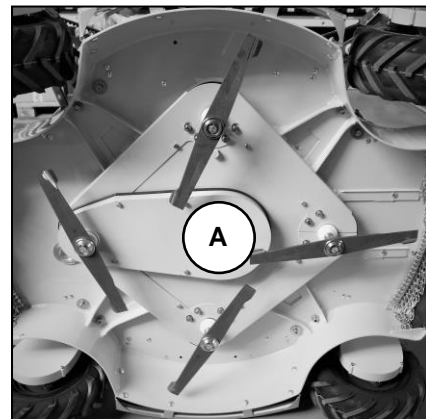

11.14 STEERING CHAIN

Check the wear and tension of the chain and the tensioning devices. The chain can be tightened by rotating the steering motor bracket after loosening two attachment bolts (see the figure).



11.15 FUSES

The fuse box (A) is placed in the space next to the battery. Inside the fuse box you can find fuses for individual circuits.

5A..... control panel, skid steering valve

30A..... battery charging

40A..... parallel protection of the main circuit, steering servomotor

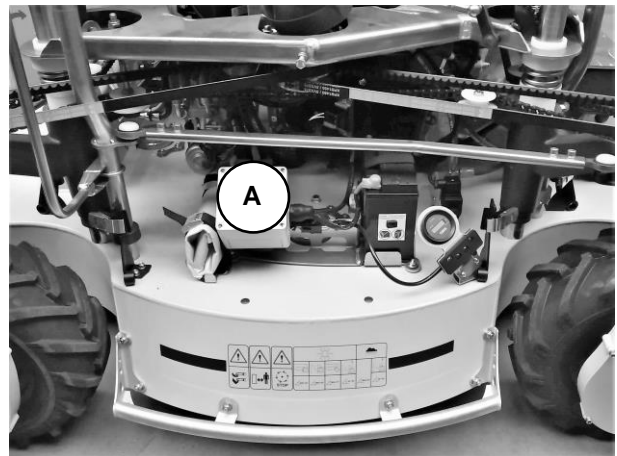

When changing fuses follow the electric current value for which the fuses are designed. Do not replace damaged fuses with fuses with a higher or lower electric current value. These could cause damage or even a fire in the mower!



11.16 MOWING BLADES

Check the state of cutting blades in regular intervals

The blades:

- Must not show signs of damage such as twisted, bent or deformed parts of blades.
- Must be properly attached by the flange in the middle of blades.
- Must be sharp.
- The fastening bolts of the flange must not be damaged.

For proper and reliable functioning, the blades are statically balanced by the manufacturer. This balance must be preserved during the entire use of the blade

The blade must be statically balanced after each sharpening

To tighten the blade, use a torque wrench and a specified tightening torque of 60 Nm

If the blades are damaged, it is prohibited to:



Straighten them

Heat them

Weld them

Ream them or otherwise change their construction.

When replacing worn-out parts follow these rules:

- The blade may only be sharpened within the permitted wear limit. Balancing must be carried out after sharpening.
- The blade cannot be repaired.
- When changing the blade, use new fastening bolts if the current ones show signs of damage. Only high-tensile steel bolts may be used for this purpose. No other steel bolts are acceptable.

- If the mowing mechanism vibrates when engaged, do not continue operating the mower, turn it off and contact your local dealer.
- To tighten bolts, use torque listed in the chart at the end of this chapter (see 11.22)

Changing the mowing blades

Raise the mowing device to the transport position.

Stop the engine, switch off the RC and push the emergency button on the body of the mower.

Disconnect the spark plug and battery.

Lift one side of the mower until it leans against the handles on the other side. Always lift the mower on the Control unit side tilt it against the fuel tank side to prevent oil entering the air cleaner.



Secure the lifted side against falling by supporting it.

Use gloves when changing the blades.

Loosen the fastening bolts. Remove the bolts and the washers. Be careful when removing the last bolt, the blade may fall to the ground.

After the blade is replaced, fasten it by working in the reversed order.

Always check the bolts when fastening the blade.

After attaching the blades, check their tightness. Be very careful when engaging the mowing mechanism for the first time after replacement. Check for unknown sounds, vibrations etc.

NOTICE:

Always lift the mower on the control unit side and tilt against the fuel tank side to prevent oil entering the air cleaner. Be aware of oil spills.

11.17 CHANGING THE WHEEL

- Change the wheels on a level, firm surface
- Turn the wheel so that the tightening nuts are accessible from the outside
- Stop the engine, remove the key from the ignition
- Secure the machine against movement.
- Lift the mower and support it under the cutter deck
- Ensure the machine is safe & supported before working on it.
- Loosen the wheel nuts, remove the wheel
- After repairing it, attach the wheel back in the reversed order.
- Use suitable tools to unscrew the nuts

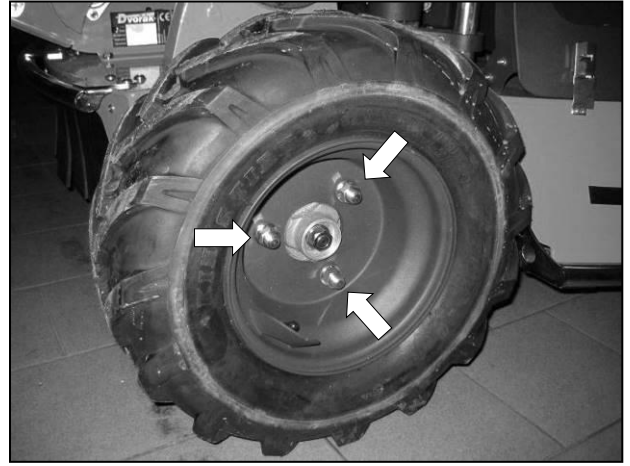

11.18 TYRE PRESSURE

Keep the specified tyre pressure. Other values may unfavourably influence the riding characteristics especially on slopes. You may even lose control of the machine.

Recommended and max. tire pressure is 300 kPa / 3,0 bar / 43 PSI



11.19 MOWING HEIGHT ADJUSTMENT MECHANISM

Keep the moving parts of the slide way clean, undamaged and without an excessive clearance

11.20 LUBRICATION

Use adequate amount of lubricant on parts, which are to be lubricated. Excessive lubricant tends to drop down and pollute both the machine and the environment. Insufficient amount requires frequent lubrications.

Chain Spray Lubricant:

INTERFLON LUBE TF



Lubricating grease:

Mobilgrease XHP 222



11.21 CLEANING THE MACHINE



Cleaning the whole machine by a power washer or similar is not recommended. Water under pressure may penetrate inside electrical parts, carburettor, air filter and cause malfunction.

Wipe other parts with tissue or brush.

Do not use gasoline or other oil products for cleaning

11.22 TORQUE CHART

Connection bolt	M 6	M 8	M 10	M 12	M 14	M 16	M 20	Wheel nut	Blade bolts
Torque /Nm/	10	25	50	85	135	215	410	50	60

11.23 TECHNICAL PLATE

The technical plate provides information on mower fillings and basic information for machine maintenance. The technical plate is placed on the machine girder.

<table style="width: 100%; border-collapse: collapse;"> <tr><td style="background-color: #cccccc;">Type</td><td>SPIDER ILD 02 SG</td></tr> <tr><td>Engine:</td><td>Kawasaki FS 691V</td></tr> <tr><td style="background-color: #cccccc;">Oil</td><td>10W40 / API SG</td></tr> <tr><td style="background-color: #cccccc;">Quantity</td><td>2,1 l</td></tr> <tr><td style="background-color: #cccccc;">Spark plugs</td><td>NGK BPR4ES</td></tr> <tr><td style="background-color: #cccccc;">Fuel</td><td>Unleaded petrol</td></tr> <tr><td colspan="2">Hydrostatic system:</td></tr> <tr><td style="background-color: #cccccc;">Oil</td><td>HV 68</td></tr> <tr><td style="background-color: #cccccc;">Quantity</td><td>8,5 l</td></tr> <tr><td colspan="2">Electronic system:</td></tr> <tr><td style="background-color: #cccccc;">Accumulator</td><td>12V/18Ah FBTX20L</td></tr> <tr><td style="background-color: #cccccc;">Fuses</td><td>5A /30A /40A</td></tr> <tr><td colspan="2">Tires:</td></tr> <tr><td style="background-color: #cccccc;">Type</td><td>16 x 6,50 - 8</td></tr> <tr><td style="background-color: #cccccc;">Pressure</td><td>max. 300kPa / 43 PSI</td></tr> <tr><td colspan="2">Lubrication:</td></tr> <tr><td style="background-color: #cccccc;">Chains</td><td>INTERFLON FIN LUBE TF</td></tr> <tr><td style="background-color: #cccccc;">Sliding surfaces</td><td>INTERFLON FIN LUBE TF</td></tr> </table>	Type	SPIDER ILD 02 SG	Engine:	Kawasaki FS 691V	Oil	10W40 / API SG	Quantity	2,1 l	Spark plugs	NGK BPR4ES	Fuel	Unleaded petrol	Hydrostatic system:		Oil	HV 68	Quantity	8,5 l	Electronic system:		Accumulator	12V/18Ah FBTX20L	Fuses	5A /30A /40A	Tires:		Type	16 x 6,50 - 8	Pressure	max. 300kPa / 43 PSI	Lubrication:		Chains	INTERFLON FIN LUBE TF	Sliding surfaces	INTERFLON FIN LUBE TF	
Type	SPIDER ILD 02 SG																																				
Engine:	Kawasaki FS 691V																																				
Oil	10W40 / API SG																																				
Quantity	2,1 l																																				
Spark plugs	NGK BPR4ES																																				
Fuel	Unleaded petrol																																				
Hydrostatic system:																																					
Oil	HV 68																																				
Quantity	8,5 l																																				
Electronic system:																																					
Accumulator	12V/18Ah FBTX20L																																				
Fuses	5A /30A /40A																																				
Tires:																																					
Type	16 x 6,50 - 8																																				
Pressure	max. 300kPa / 43 PSI																																				
Lubrication:																																					
Chains	INTERFLON FIN LUBE TF																																				
Sliding surfaces	INTERFLON FIN LUBE TF																																				

11.24 TOOLS

Spider 2SGS is equipped with a basic set of tools, which allow regular maintenance and basic servicing. The tools are based under the side cover next to the fuse box (see figure below). The tool roll is also equipped with a pocket for the business card of your local authorized service/dealer.

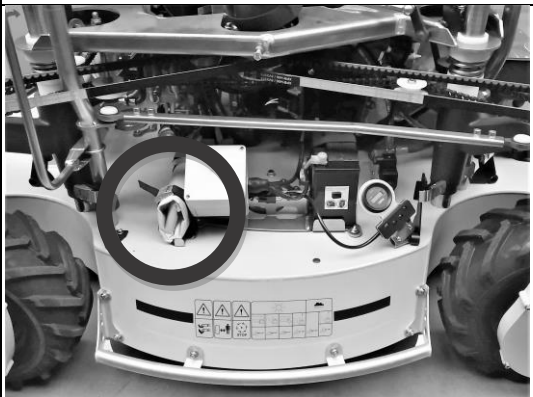
List of tools	Use	Placement on the machine
Spark plug spanner 21 mm	Spark plugs	
Socket head 19 mm	Change of blades	
Socket head 17 mm	Change of wheels	
Socket head 15 mm	Tightening of drive belts	
Lever handle	-	
Flat spanner 10-13 mm	Tightening of drive belts	
Flat spanner 16-17 mm	By-pass, tightening of steering chain	
Hex-wrench IMBUS 5 mm	Wheel suspension	
Hex-wrench IMBUS 6 mm	Wheel suspension	
Hex-wrench IMBUS 8 mm	Tightening of steering chain	
Screwdriver flat-tip / crosshead	Fuse box	
Fuses 5A, 30A, 40A	Fuse box	

11.25 AUXILIARY DRIVE BRAKE

The machine is equipped with an auxiliary drive brake, which brakes the wheels in situations, when the pressure in the hydraulic circuit drops (engine shut down, air in the hydraulic circuit, result of using the “Emergency stop” buttons). The auxiliary drive brake works on the principle of a band brake, where the braking band brakes the pulley of the hydraulic motor and consequently also the wheels. The brake is controlled by a brake cylinder, which is connected to the filling circuit of the hydraulic pump. The braking effect will take place when the pressure in the hydraulic system drops. When the pressure in hydraulic system increases, the brake will be disengaged. The brake includes a system, which allows the brake to be manually disengaged. If used together with the hydraulic by-pass, the machine can be moved without using its own drive (pushed, towed away). This system of moving may be used only when the hydraulic drive is not functional and the machine cannot use its own drive.

- For manual manipulation with the machine secure the brake lever by the Secure pin in position 1 (see figure)
- For normal operation if it absolutely necessary that the hydraulic by-pass bolt on the hydraulic pump is tightened and the Secure pin of the auxiliary brake released – position 2 (see figure)



Before operation, make sure that the hydraulic pump by-pass bolt is tightened and the Secure pin of the auxiliary drive brake released (position 2)



Incorrect release of the auxiliary drive brake Secure pin may lead to undesirable behaviour of the machine on slopes, the machine may uncontrollable drive down the slope



Daily check the brake lining. If the lining gets thinner than 1 mm, replace it immediately. Have the brake adjusted by an authorized service/dealer (every 200 operating hours).



The auxiliary drive brake is designed only to brake the wheels during the drop of pressure in the hydraulic circuit and may not be used for securing the machine and parking on slopes.

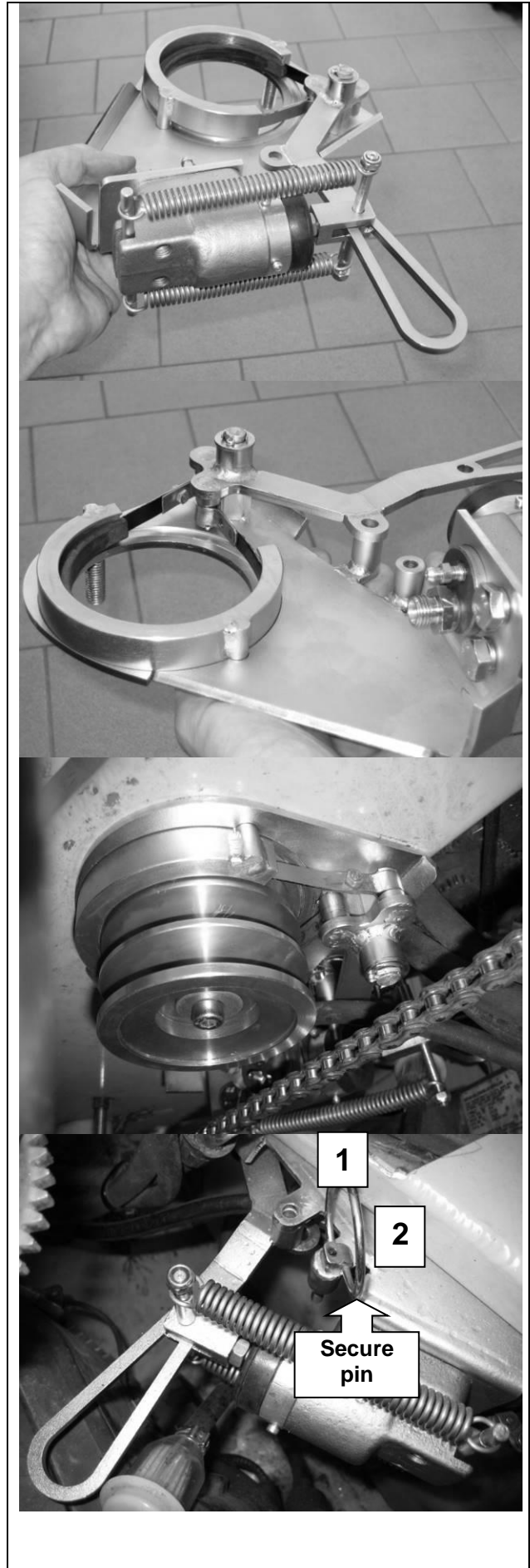

11.26 BATTERY MAINTENANCE

The battery should be examined for cleanliness at regular intervals.

Read the Safety page.

Keep cell terminals and connectors free of dust and corrosion. Terminal corrosion may affect the performance of the battery and could present a safety hazard. Should corrosion be observed, disconnect the battery, unbolt and remove the connectors, and remove the corrosion by brushing the terminals and connectors with a dilute solution of baking soda and water (sodium bicarbonate). Reapply an anti-oxidizing grease before reconnecting and bolting the connectors. Always maintain proper records.

DO NOT UNDER ANY CIRCUMSTANCES REMOVE PRESSURE RELIEF VALVES AND NEVER ADD WATER.

How to store your battery.

To ensure our batteries safely reach their maximum shelf life, the average annual storage temperature should be 15°C. The short-term storage temperature must not exceed 25°C or battery life may be affected.

Remove the battery from the vehicle.





Find a cool, dry place to keep your battery.

Make sure the battery is fully charged and recharge it approximately every two months.

Clean any terminal corrosion may that affect the performance of the battery and could present a safety hazard. Remove the corrosion by brushing the terminals and connectors with a dilute solution of baking soda and water (sodium bicarbonate). Reapply an anti-oxidizing grease before reconnecting and bolting the connectors.

Test a battery

The best and easiest way to test a battery is using a voltmeter or multimeter to measure the voltage. Once you know the exact voltage, use the table below to gauge the state of charge.

Voltage		Stage of Charge	Status	Action Required
Freshpack	AGM			
> 12.6 Volt	13 Volt	100%		No action necessary
12.4 Volt	12.8 Volt	75%		No action necessary
12.1 Volt	12.5 Volt	50%		Battery needs to be charged
11.9 Volt	12.2 Volt	25%		The battery must be recharged urgently
< 11.9 Volt	< 12.0 Volt	0%		Battery is no longer usable

Battery Testing Chart with Status of Chart

Make sure the battery is charged.

To ensure that the battery can supply its stated starting power, it first needs to be fully charged. The recommended charging current is 10% of nominal capacity in amperes (e.g. a 4 Ah battery requires a 0.4A [Ampere] charging current). We recommend that you ensure your battery is fully charged before fitment to ensure a long service life.

12 TROUBLESHOOTING

Engine faults and their probable solution			
Fault	Probable cause	Solution	
Engine doesn't start	It doesn't turn over	No connection with the remote	Check the connection and signal, empty battery RC
		Broken starter relay	Test/measure/replace the starter relay
		Exhausted battery	Charge/change battery, check fuses and cable connections to fuses
		Drive system isn't in neutral position ("N" Led isn't lit)	Adjust the drive servo to neutral position if not possible change servomotor
		Are the mowing blades disengaged	Disengage the mowing blades
		Mowing clutch is broken (bearings burned out)	Replace
		Starter motor doesn't work consequently	Replace
		Interrupted cabling harness	Check cabling harness and fuses replace where need
	It turns over but	Insufficient amount of fuel	Replenish fuel
		Loosened weight of fuel hose in fuel tank, hose sucks air	Reattach weight to the end of the hose
		Blocked fuel hoses	Clean fuel hoses
		Clogged up fuel filter	Replace fuel filter
		Broken fuel pump	Exchange fuel pump
		Solenoid valve of the carburettor doesn't give fuel	Check/exchange valve, check contacts and cabling
Check breather filter		Clean exchange the filter	
The motor runs irregularly	Bad spark plugs	Clean/exchange spark plugs	
	Broken ignition coils	Exchange ignition coils	
	Water in the fuel, carburettor	Clean carburettor thoroughly	
	Blocked fuel hoses	Clean fuel hoses	
	Bad contact solenoid carburettor	Check contact points solenoid carburettor	
	Polluted carburettor	Clean the carburettor	
	The engine has infiltrated/false air	reseal the joints, carburettor/inlets/cylinder	
Engine doesn't have enough power	Works on both cylinders	Polluted air filter	Clean/replace the air filter
		Cylinders don't have enough compression	
		Bad fuel	Replace fuel, natural 95 only
	Only one cylinder is working	Loosened rocker arm, detached lifting rod valves	Reassemble and re-set valve clearances
		Bad spark plug	Clean/replace spark plug
		Broken ignition coil	Replace ignition coil
Engine smokes excessively	Black smoke	Heavily polluted air filter	Clean/replace air filter
		Jammed choke	Oil the choke cable and check the choke spring
		Bad valve in the floater chamber of the carburettor	Replace the valve
	White smoke	To much oil in the engine	Check oil level in the engine, remove excess
		Bad quality or wrong fuel	Replace fuel, natural 95 only
		Mower was in servicing position	Temporary problem, not a real problem

Mowing unit faults			
Fault		Probable cause	Solution
Mowing unit can't be turned on	Clutch engages and immediately disengages (control LED turns on but immediately turns off again)	Electromagnetic clutch is broken	Replace electromagnetic clutch
	Clutch does not engage	Clutch connector is loosened	Check the connector and cabling
	Clutch engages	Broken V-belt B 1160	Replace V belt
Leaves unmown grass behind, only one blade is turning		Broken V-belt XPB 2410	Replace V-belt

Turning faults		
Fault	Probable cause	Solution
The mower does not turn	Bad contact between the carbon and the commutator of the turning servomotor (servo reacts to tapping)	Clean the commutator and check the carbon blocks
	Disengaged power cable	Engage power cable
	Broken steering servomotor	Replace
	Exhausted battery	Check/recharge battery, check fuses and cable connections to fuses
	Control unit fault	Replace
	Broken joystick in remote control	Replace
The mower turns around it's vertical axis (crabbing)	Bad wheel geometry	Set wheel geometry right
	Steering chain is loose	Tighten steering chain
	Tyres aren't inflated correctly	Inflate tyres correctly
	Usage of tyres with different wear	Use tyres with same wear (profile depth)

Driving faults			
Fault	Probable cause	Solution	
Machine doesn't have power when driving on slopes.	Not enough hydraulic oil in the oil tank	Replenish hydraulic oil	
	Worn mechanical parts of the hydraulic system	Exchange worn parts	
	Loosened bypass bolt on hydraulic pump	Tighten bolt	
	Broken drive servomotor	Exchange servomotor	
Machine doesn't react to the drive servomotor	Pump ventilator doesn't turn	Broken V-belt B 17x965	Replace V-belt
	Pump ventilator does turn	Snapped pin of arm on hydraulic pump	Replace pin
		Servomotor isn't in neutral position/Broken servomotor	Set neutral position/Replace drive servomotor
		Loosened bypass bolt on hydraulic pump	Tighten bolt
The machine accelerates, decelerates on it's own	Broken drive servomotor	Replace Drive servomotor	
	Broken Control unit	Replace unit	
The machine drives when turning up the throttle (drive servomotor makes noise)	Throttle servomotor is broken which influences the drive servomotor	Replace throttle servomotor	

Problems with skid steering			
Fault		Probable cause	Solution
Skid steering does not respond	Relay in the elevation module doesn't react	To large gap between Inductive sensor and inductive segment	Set distance to 2mm, LED diode on the sensor has to Light up
		Inductive sensor is broken	Replace
		Broken Elevation module	Replace
	Relay in the elevation module reacts	The skid steering valve doesn't work	Check electrical contacts on the on the valve unit Replace the electromagnetic valve unit

Problems with the elevation		
Fault	Probable cause	Solution
Slow height change when changing cutting height	One of the elevation servomotors is broken	Check which of the servo motors is broken and replace
Machin doesn't react to elevation changes	Elevation module is broken	Replace
	Worn elevation gears	Replace
Elevation regulation does not stop when at max or min height	one of the height sensors is broken	Replace

Issues with the remote control, and electrical system			
Fault		Probable cause	Solution
Machine turns of while working	Allows repeated starting	Interference nearby (High voltage, Transmitters)	Not a machine fault
		Bad sparkplugs, interfere with the remote/unit	Replace spark plugs
	Machine cannot be started (motor does not turn, starter relay does react)	The combination of a weak battery, a worn drive servomotor can burn out the fuses for the alternator	Replace the alternator fuses
The machine keeps running for about 2 seconds after pushing the off button		Burned out ignition coils (often caused by incorrect battery connection (swapping + for -))	Replace ignition coils
fuses blow out often	Alternator fuses 2x15A (blue)	battery is in bad shape, often caused by turning the wheels while standing this overloads the alternator	Test the state of the battery, replace a bad battery. Steer while moving.
	Drive servomotor and control unit fuses 2x 20A (Yellow)	Extreme power consumption due to burned out coils in the turning servomotor, under inflated tyres	Replace drive servomotor. Check the tyre pressure as prescribed

13 MAINTENANCE AFTER SEASON

When the season is over or if the machine is not going to be used for longer than 1 month, it is advisable to prepare it for storage.

If fuel stays in a tank longer than 1 month without moving, it may create sticky sediment that can unfavourably affect the carburettor and the whole fuel system and cause engine malfunction.

- Thoroughly clean the whole machine, especially the mowing mechanism.
- Replace damaged or worn-out parts
- Check all bolted connections. Tighten all loose nuts and screws.
- Lubricate all mobile parts – the whole machine (according to the lubrication plan)
- Empty the fuel tank and let the engine run until it runs out of fuel.
- When emptying the fuel tank, work in an open area outside.
- Prepare the engine for storage (according to the user's manual of the engine)
- Disconnect the ignition cable.
- Unscrew the spark plug and pour a little oil into the cylinder bore (about 1 cm / 0,4 inch).
- Turn the engine by starting it shortly with the ignition key without spark plugs on.
- Screw the spark plug back hand tight. Do not connect the cable.
- Dismount the Accumulator and store it on the dry and warm place.
- Keep the mower on the save and dry place. Use the permeable cover to save the mower against the corrosion.

Summary of after season maintenance

checking/change of engine oil	
exchange of oil filter	
checking/change of hydraulic oil	
exchange of hydraulic filter	
checking and clearing of engine air filters	
checking / replacing the spark plugs	
check engine valve clearance	
check wiring - fuses, measurement of recharging, battery	
checking of weight in the fuel tank	
checking of wheel hub nut tightening	
checking of wheel chain tightening	
checking of tightening of both angle gear shafts vertical and horizontal	
checking of seating tightening of wheel housing to angle gear	
checking of cutting height regulation	
checking of hydraulic oil leakage	
visual checking of frame welding defects, straightening of skeleton	
checking of mowing device bearings	
checking of mowing device belts and pulleys	
checking of pulleys wear of mowing device	
checking and adjusting of clutch	
checking of blade/s	
checking of angle gear teeth and filling level	
checking of tyre pressure 2,5/3,0 bar	
checking and adjusting of cross geometry	
checking of tightening of steering chain	
checking and adjusting of wheel geometry	
checking / tightening of driving belts	
lubrication of steering chain	
checking of tightening Engine bolts	
checking of function of skid steering	
checking and adjusting of hydr.pump servo neutral position	
checking and lubrication of winch chain	
checking and adjusting of winch by throttle valve	
checking/exchange of winch rope	
lubrication of all moving mechanical parts	
general checking of all mower functions	

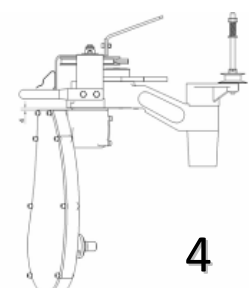
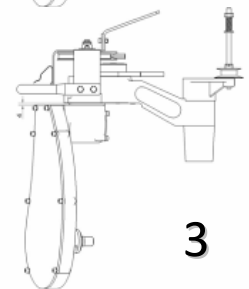
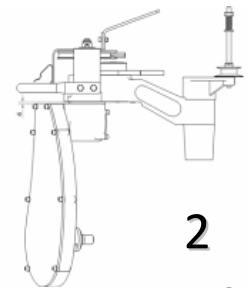
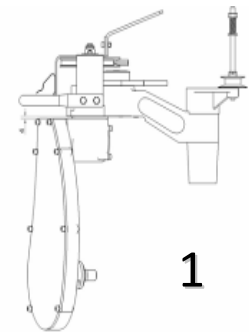
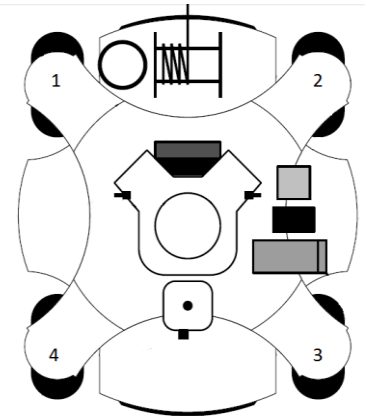

14 WARRANTY CONDITIONS

LIMITED WARRANTY FOR NEW SPIDER EQUIPMENT

GENERAL PROVISIONS – The warranties described below are provided by DVOŘÁK – svahové sekačky s.r.o. (“Spider”) to the original purchaser of new equipment from Spider or authorised Spider Distributors/Dealers. Under these warranties Spider will repair or replace, at its opinion, any covered parts which is found to be defective in material or workmanship during the applicable warranty term. Warranty service must be performed by a Distributor/Dealer or service centre authorised by Spider to sell and/or service the type of equipment involved, which will use only new or remanufactured parts or components furnished by Spider. Warranty service will be performed without charge to the purchaser for parts and labour. The purchaser will be responsible, however, for any service call and/or transportation of product to and from the Distributor’s/Dealer’s or service centre’s place of business, for any premium charged for overtime labour requested by the purchaser, and for any service and/or maintenance not directly related to any defect covered under the warranties below.

- a) Spider provides Warranty:
- for new Products according to the valid Warranty Conditions Spider will provide the Distributor/Dealer with a Warranty for the Product for a maximum period of 36 months. from the day the Product was delivered to the Distributor/Dealer
 - 24 months for the Customer after purchase and registration of the Product
 - for new Spare Parts delivered outside the Product Warranty for a period of 3 months from the day these were delivered to the Customer, but only under the condition that these were installed and mounted by an authorized service Distributor/Dealer. Otherwise the Warranty is forfeit.
 - For new spare parts delivered under Warranty the Warranty period expires together with the Warranty period of the whole Product
- b) The Distributor/Dealer is obliged to ensure performance of warranty inspections on the Product as prescribed in the Operator’s Manual.
- c) In order for a warranty claim to be acknowledged, the purchaser must have had all prescribed warranty inspections performed and recorded.
- d) In the case of defects reclaimed by the Customer in terms of the warranty period, the Distributor/Dealer assesses and determines whether this concerns a defect in the warranty period, which can be acknowledged (acknowledged warranty) or not and ensures repairs are carried out.
- e) If the Distributor/Dealer assesses the defect as one that can be acknowledged (acknowledged warranty), they are obliged to request in writing that Spider acknowledges such warranty repair at the latest within one month after the end of the month in which such warranty repair was performed. This can only be done through a standard “Warranty Claim Report” form. Such request will include all information about the method of assessment and solution of the warranty (description of defect, identification of defect, description of repair, list of defective parts, hourly work by the service centre, specification of costs for repair, photo/video documentation of the repaired part). Spider is obliged after investigation, to make a decision on this request as whether to acknowledge the warranty or not.
- f) Spider will make a decision about the acknowledgement of the warranty claim without unnecessary delay, latest within 60 days since the warranty claim is filed.
- g) If the warranty is acknowledged, Spider will write out a credit note to the Distributor/Dealer for costs connected with the warranty repair – i.e. the cost of spare parts and the hourly rate for service work according to the valid repair norms.
- h) Spider is entitled to reject such warranty claim if the warranty was acknowledged by the Distributor/Dealer in conflict with the warranty conditions. In such a case, Spider is not obliged to reimburse the Distributor/Dealer for costs for performance of such warranty repair work.
- i) Acknowledged warranty repairs of commercial models (Spider XLINER, Spider ILD01, Spider ILD02, Spider 2SGS and higher) up to the level of EUR/USD 100.00 (one hundred EUR/USD) per case are not covered by Spider, costs connected with such repairs are included in the Distributor’s/Dealer’s profit margin.

- j) The Distributor/Dealer is obliged to ensure clear marking and storage of damaged spare parts, which were replaced under warranty for the period of min. 12 months, as well as of all-important documents pertaining to such warranty repair.
- k) The selling Distributor/Dealer has no authority to make any warranty, representation, condition or promise on behalf of Spider, or to modify the terms or limitations of this warranty in any way and makes no warranty on any other item unless it delivers to the purchaser a separate written certificate specifically warranting the item.
- l) Spider is not responsible for the following: (1) Used equipment; (2) Any equipment that has been altered or modified in ways not approved by Spider, including, but not limited to, setting injection pump fuel delivery above Spider specifications; Depreciation or damage caused by normal wear, lack of reasonable and proper maintenance, failure to follow operation instructions, misuse, lack of proper protection during storage, or accident; (4) Any repairs done by the Customer; (5) Normal maintenance parts including blades, hydraulic hoses, belts, bearings, spark plugs, filters, chains, tires, winch ropes etc. and service.
- m) To secure warranty service, the purchaser must (1) Report the product defect to an authorised Distributor/Dealer and request repair within the applicable warranty term, (2) Present evidence of the warranty start date, and (3) Make the equipment available to an authorised Distributor/Dealer or service centre within a reasonable period of time.
- n) Every Distributor/Dealer must ensure that the Product is registered by the Customer on www.slope-mower.com/machine-registration/ within seven (7) days after delivery in order to receive the full warranty of 24 months/800 working hours, whichever happens first.
- o) All Demo units will be registered by Spider on the date of delivery to the Distributor/Dealer. All Demo units will be appointed by Spider.

In Pohled, January, 2019

15 SERVICE RECORDS



SPIDER 2SGS

Warranty Inspection after 200 Operating Hours

Date: _____

Inspection description:

Defects found:

Parts changed:

Part number	Part description	Qty

Service shop signature:

Customer signature:
